



PROFILE

Nationality: Italian

Date of birth: April 19., 1976

Medical Degree: Policlinico Universitario di Palermo (Italy, 2003)

Languages: Italian (native)
English

Consultant: Tokyo (2003)
Eritrea (2008)
Milano (2015)
Palermo (2017)
Bergamo (2018)

Present status:

MD for Azienda Provinciale Sanitaria di Palermo, Public Health Sistem, High Risk Pregnancy Gyn. and Obs. Dep. Palermo, Italy.

Mentions:

Hysteroscopy Unit, Scientific Consultant of RZ Medizintechnik, developer of Rotating Hysteroscopy Instruments, Bipolar Resection Set and Accardi's Cold Knives.

Dr. Antonio Accardi

- Clinical and surgery formation in Humanitas Cancer Center and Research Hospital
- Hysteroscopic surgery formation in the most important school of the world
- Founder and Chief of the Hysteroscopi outpatient Unit in Humanitas Cancer Center and Research Hospital of Milano and Bergamo
- Scientific Director, Surgeon, Speaker and tutor for numerous Hysteroscopy workshops





Accardi Hysteroscopy & Intrauterus High-Frequency Surgery Set

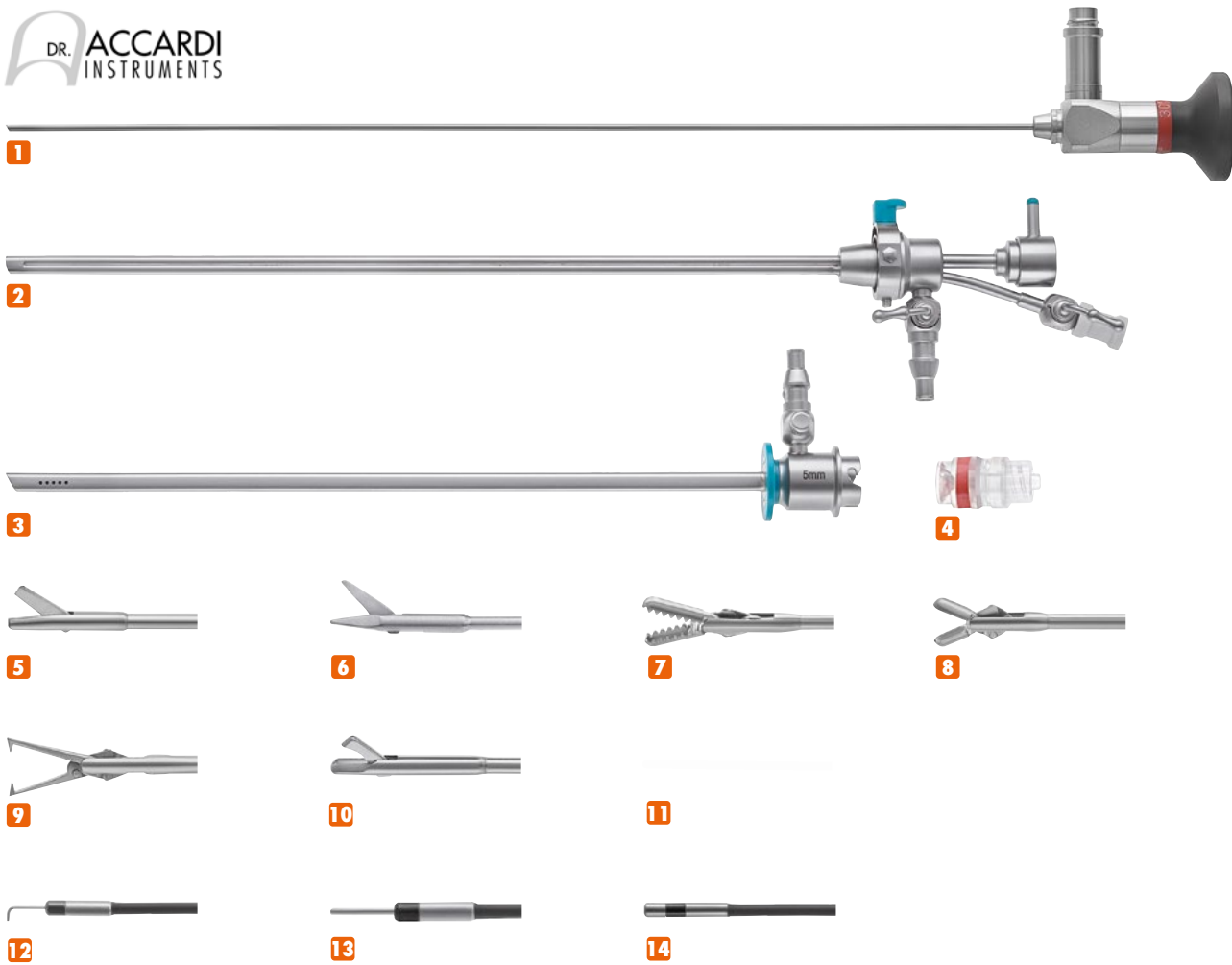

351-900-902 Accardi Hysteroscopy & Intrauterus High-Frequency Surgery Set

1	Midi Hysteroscope, \varnothing 2.9mm, 30°	351-829-030	1 pc.
2	Operating Sheath, 5 Charr.	351-400-143	1 pc.
3	Outer Sheath, \varnothing 5mm	351-400-150	1 pc.
4	Disposable Silicon Valve, package with 10 pcs.	351-905-105	1 pc.
5	5 Charr. semi-rigid Scissors, blunt, 400mm working length	351-100-305	1 pc.
6	5 Charr. semi-rigid Scissors, sharp, 400mm working length	351-118-305	1 pc.
7	5 Charr. semi-rigid Grasping Forceps, 400mm working length	351-116-305	1 pc.
8	5 Charr. semi-rigid Biopsy Forceps, 400mm working length	351-120-305	1 pc.
9	5 Charr. semi-rigid Tenaculum Forceps, 400mm working length	351-117-305	1 pc.
10	5 Charr. semi-rigid Biopsy Punch Forceps, 400mm working length	351-126-305	1 pc.
11	5 Charr. Palpation Probe, 400mm working length	351-125-105	1 pc.
12	5 Charr. Bipolar Needle Electrode, 90°, 360mm working length	351-360-015	1 pc.
13	5 Charr. Bipolar Needle Electrode, straight, 360mm working length	351-360-005	1 pc.
14	5 Charr. Bipolar Ball Electrode, 360mm working length	351-370-105	1 pc.

CONFIGURATIONS by RZ Hysteroscopy Equipment Set



1

4



2

10



6

5



7

8

3



9

351-900-906 Hysteroscopy Equipment Set

1	Basic Irrigation Pump P1	351-100-200	1 pc.
2	3-Chip HD Camera F4	300-001-804	1 pc.
3	TV-Coupler, f=14mm	300-001-813	1 pc.
4	27" Radiance Monitor	300-010-226	1 pc.
5	LUMEN LED 1 Light Source	300-900-180	1 pc.
6	Fiber Optic Light Cable, 2300mm	250-035-230	1 pc.
7	Adapter RZ/Storz	250-039-000	1 pc.
8	Adapter RZ/Storz/Olympus	250-042-000	1 pc.
9	RZ Trolley	300-001-999	1 pc.
10	Highfrequency Generator G44, 230V	700-340-400	1 pc.



18.5 Charr. Grazia Hybrid Resectoscope Set

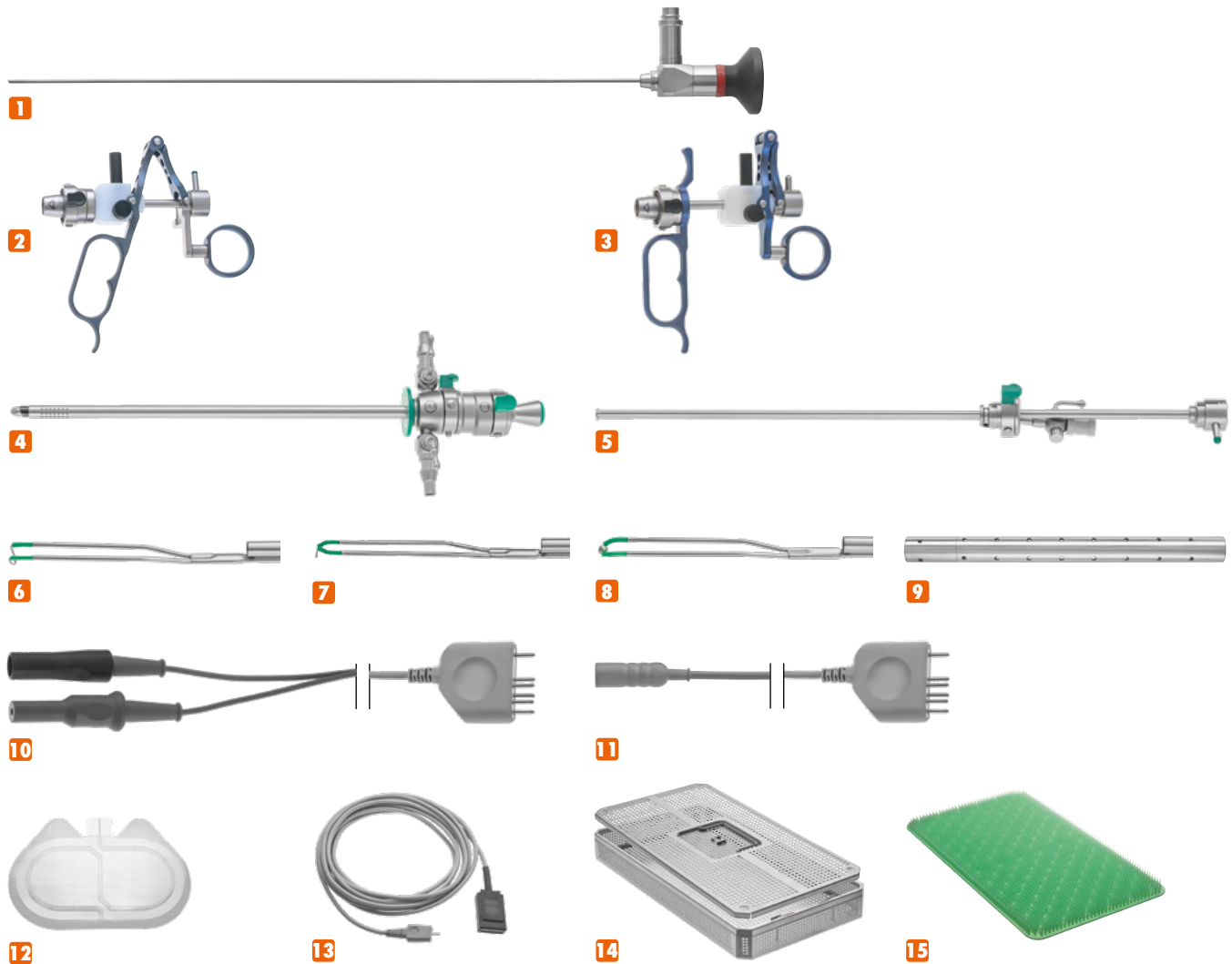

351-900-911 18.5 Charr. Grazia Hybrid Resection Set

1	Midi Hysteroscope, Ø 2.9mm, 30°	351-829-030	1 pc.
2	Grazia HYBRID Working Element, active*	351-400-201	1 pc.
3	Grazia HYBRID Working Element, passive*	351-400-200	1 pc.
4	Resectoscope Sheath, rotatable, ceramic tip	351-000-185	1 pc.
5	Visual Obturator, with 5 Charr. working channel	351-000-180	1 pc.
6	Loop Electrode	351-000-201	1 pc.
7	Knife Electrode	351-000-203	1 pc.
8	Ball Electrode	351-000-205	1 pc.
9	Sterilization tubes for electrodes	253-300-999	1 pc.
10	SDS Cable, 4.5m, bipolar	700-500-453	1 pc.
11	SDS Cable, 4.5m, monopolar	700-501-453	1 pc.
12	Disposable Neutral Electrode, pack of 50 pcs.	700-503-000	1 pc.
13	Cable for Neutral Electrode	700-503-003	1 pc.
14	Stainless Steel Container, perforated, 480x254x55mm, with lid	600-485-555	1 pc.
15	Silicone mat, green, 440x230mm	600-281-003	1 pc.

*please choose between active or passive working element



24 Charr. Hybrid Resectoscope Set

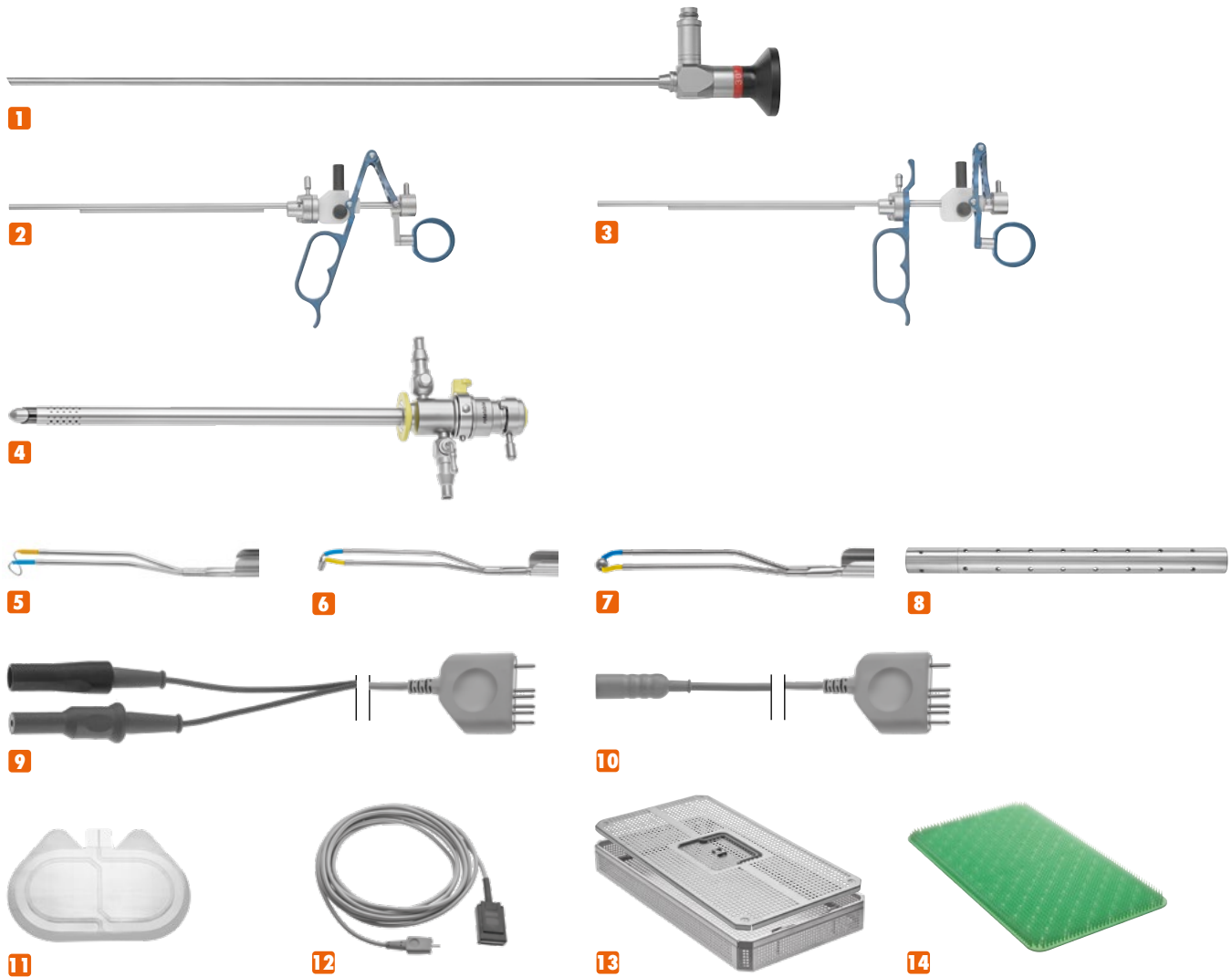

351-900-912 24 Charr. Hybrid Resection Set

1	Midi Hysteroscope, Ø 2.9mm, 30°	351-804-030	1 pc.
2	HYBRID Working Element, active*	253-000-401	1 pc.
3	HYBRID Working Element, passive*	253-000-400	1 pc.
4	Resectoscope Sheath, rotatable, ceramic tip	253-000-256	1 pc.
5	Cutting Electrode	253-400-201	1 pc.
6	Collins Coagulation Electrode	253-400-203	1 pc.
7	Ball Electrode	253-400-205	1 pc.
8	Sterilization tubes for electrodes	253-300-999	1 pc.
9	SDS Cable, 4.5m, bipolar	700-500-453	1 pc.
10	SDS Cable, 4.5m, monopolar	700-501-453	1 pc.
11	Disposable Neutral Electrode, pack of 50 pcs.	700-503-000	1 pc.
12	Cable for Neutral Electrode	700-503-003	1 pc.
13	Stainless Steel Container, perforated, 480x254x55mm, with lid	600-485-555	1 pc.
14	Silicone mat, green, 440x230mm	600-281-003	1 pc.

*please choose between active or passive working element

FULL HD HYSTEROSCOPES

- Colour coded rings identify the direction of view
- 3-step light post adapters for the most common light cables
- Sapphire glasses to protect lens system
- Optimized glass fibre arrangements for an uniform image brightness
- Fully Autoclavable at 134°C and 2.3bar

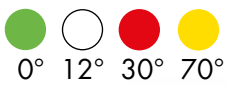

FULL HD

ENDOSCOPES FOR HYSTEROSCOPY

300mm working length, 356mm overall length

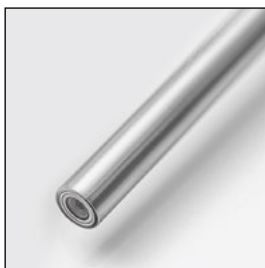
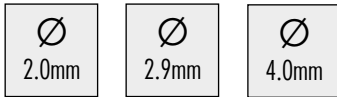

● 0° DIRECTION OF VIEW

∅ 2.0mm	351-720-000
∅ 2.9mm	351-829-000
∅ 4.0mm	351-804-000



○ 12° DIRECTION OF VIEW

∅ 2.9mm	351-829-012
∅ 4.0mm	351-804-012



● 30° DIRECTION OF VIEW

∅ 2.0mm	351-720-030
∅ 2.9mm	351-829-030
∅ 4.0mm	351-804-030



● 70° DIRECTION OF VIEW

∅ 2.9mm	351-829-070
∅ 4.0mm	351-804-070

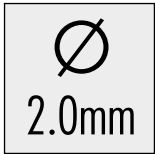

MINI DIAGNOSTIC HYSTEROSCOPE SETS

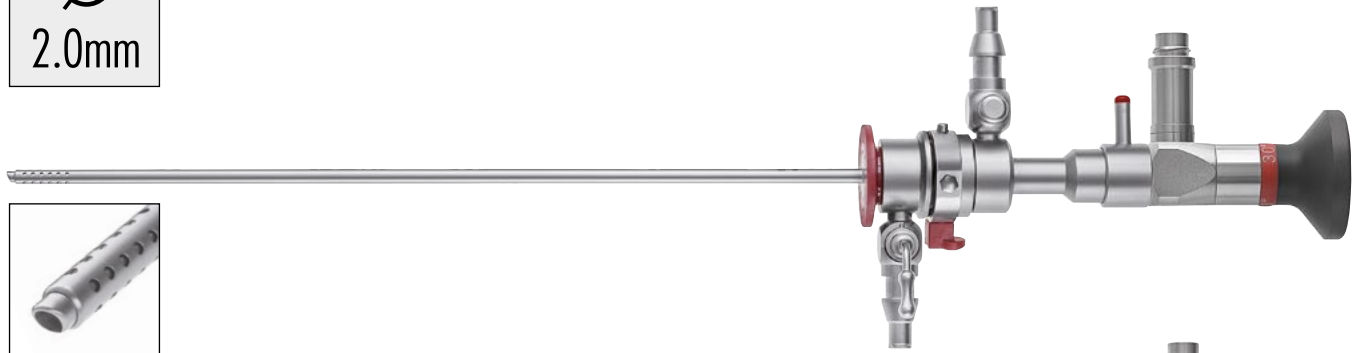

Mini-Hysteroscope, ∅ 2.0mm, working length: 260mm, overall length: 315mm
 351-720-000 0°
 351-720-030 30°

Sheaths, suitable for ∅ 2.0mm system



Diagnostic sheath for 2.0mm Hysteroscope, including obturator, ∅ 2.9mm, working length: 228mm



351-720-200
for 0° Hysteroscope



351-720-300
for 30° Hysteroscope

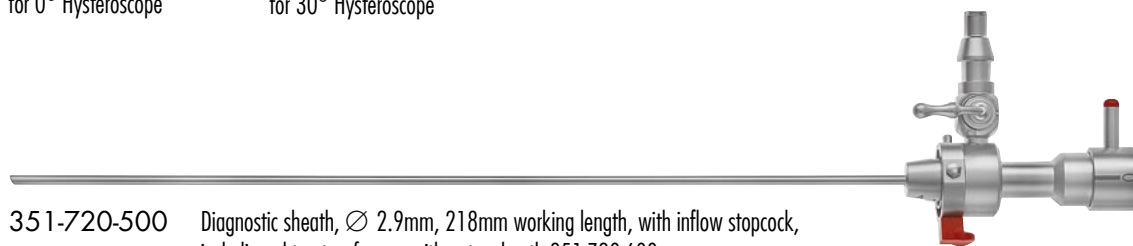

351-720-500 Diagnostic sheath, ∅ 2.9mm, 218mm working length, with inflow stopcock, including obturator, for use with outer sheath 351-720-600 and Mini Hysteroscope 351-720-030



351-720-600 Outer sheath, ∅ 3.7mm, 200mm working length, with outflow stopcock, for use with diagnostic sheath 351-720-500

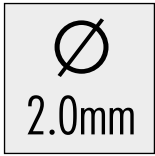

MINI OPERATING HYSTEROSCOPE SETS

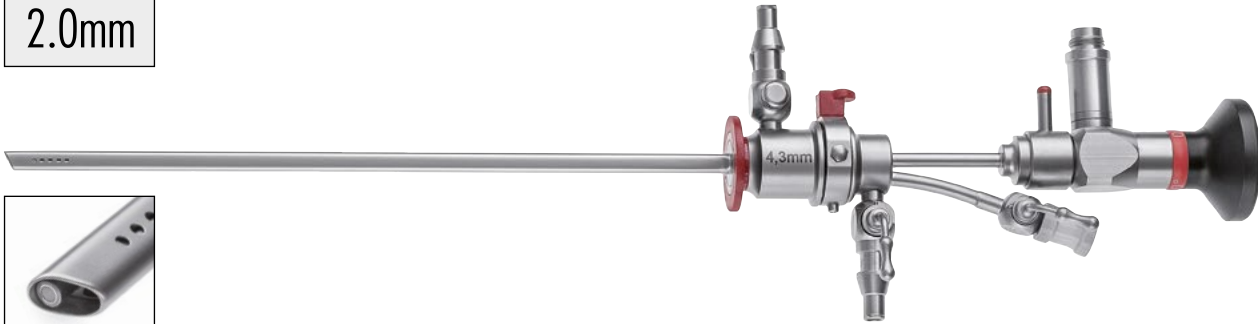

351-720-550

Operating sheath, with working channel for use with 5 Charr. instruments, with inflow stopcock, for use with outer sheath 351-720-650 and Mini Hysteroscope 351-720-030



351-720-650

Outer sheath, ∅ 4.3mm, oval shape, 192mm working length, with outflow stopcock, for use with operating sheath 351-720-550

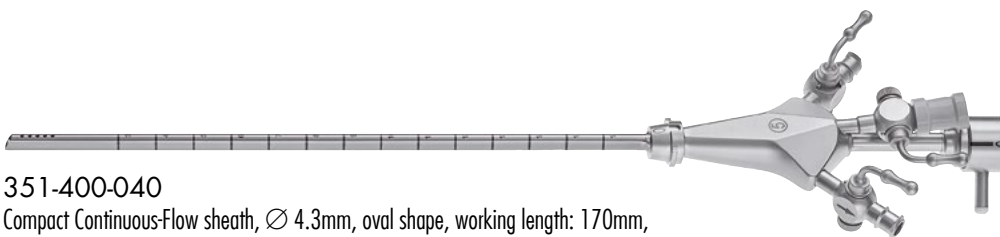

351-400-040

Compact Continuous-Flow sheath, ∅ 4.3mm, oval shape, working length: 170mm, with working channel for use with 5 Charr. instruments and 2 stopcocks for inflow and outflow, for use with Mini Hysteroscope 351-720-030

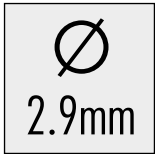

MIDI DIAGNOSTIC HYSTEROSCOPE SETS



Midi-Hysteroscope, Ø 2.9mm, working length: 300mm, overall length: 355mm
 351-829-000 0°
 351-829-030 30°

Midi diagnostic sheaths, suitable for Ø 2.9mm system

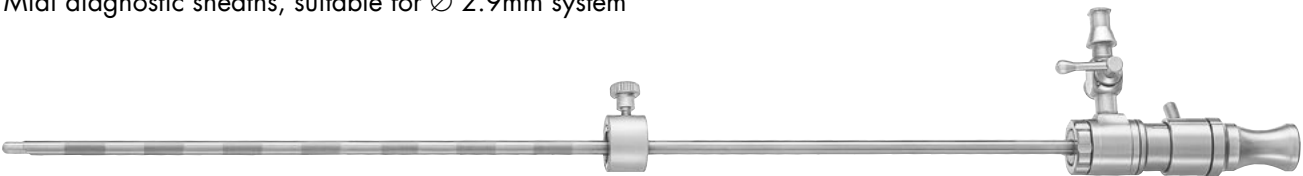

351-230-040 Diagnostic sheath, Ø 4.0mm, 270mm working length, with rotating stopcock, including obturator and distance holder, for use with 351-829-030 or 351-829-130

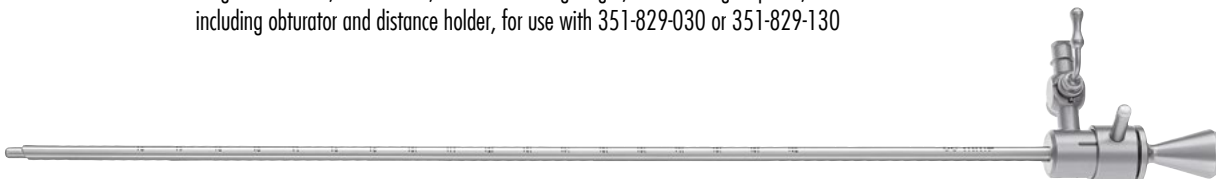

Diagnostic Sheath, Ø 4.0mm, 270mm working length, with rotating stopcock, including obturator
 351-300-040 for 0° Hysteroscope
 351-330-040 for 30° Hysteroscope



Diagnostic Sheath, Ø 4.0mm, 270mm working length, with fixed stopcock, including obturator, recommended for CO₂ gas dilation
 351-500-040 for 0° Hysteroscope
 351-530-040 for 30° Hysteroscope



351-300-037 Diagnostic sheath, Ø 4.0mm, 267mm working length, with inflow stopcock, including obturator, for use with outer sheath 351-300-050 and Midi Hysteroscope 351-829-030 or 351-829-130

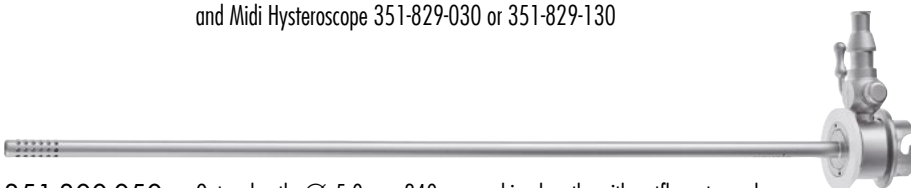

351-300-050 Outer sheath, Ø 5.0mm, 240mm working length, with outflow stopcock, for use with diagnostic sheath 351-300-037

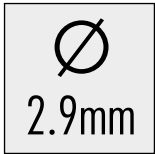

MIDI OPERATING HYSTEROSCOPE SETS



5
CHARR.
Instruments

192
mm
Working
length

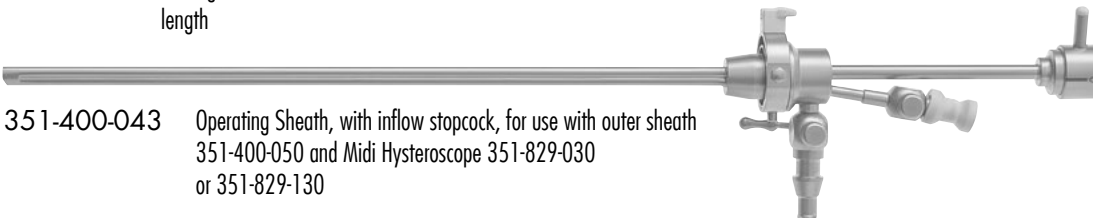

351-400-043 Operating Sheath, with inflow stopcock, for use with outer sheath 351-400-050 and Midi Hysteroscope 351-829-030 or 351-829-130

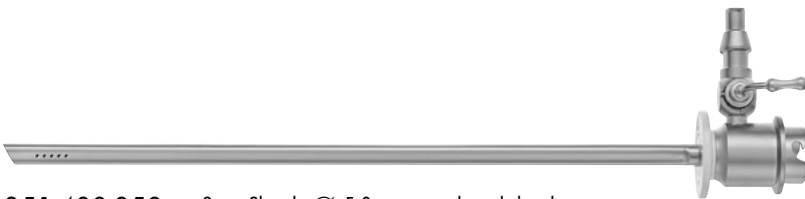

351-400-050 Outer Sheath, ∅ 5.0mm, pear-shaped sheath, with outflow stopcock, for use with operating sheath 351-400-043

5
CHARR.
Instruments

216
mm
Working
length



351-400-143 Operating Sheath, with inflow stopcock, for use with outer sheath 351-400-150 and Midi Hysteroscope 351-829-030 or 351-829-130

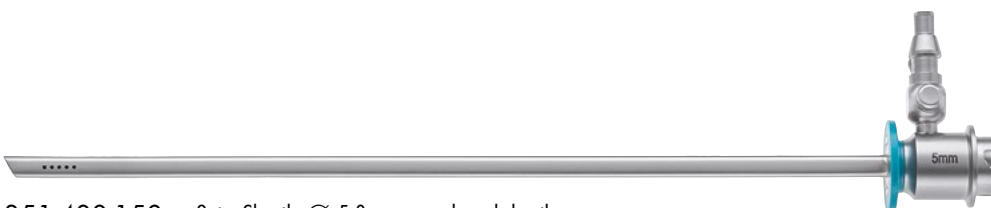

351-400-150 Outer Sheath, ∅ 5.0mm, pear-shaped sheath, with outflow stopcock, for use with operating sheath 351-400-143

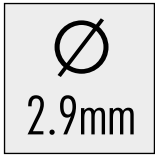

MIDI OPERATING HYSTEROSCOPE SETS

7
CHARR.
Instruments

216
mm
Working
length



351-400-750
Operating Sheath, ∅ 4.5mm, for use with 351-829-030 and 351-400-743



351-400-743 Outer Sheath, ∅ 5.0mm,
for use with 351-829-030 and 351-400-750



351-905-105
Disposable Silicone Valve with
LuerLock connection for use
with 3 - 10 Charr. instruments
sterile packed,
package with 10 pieces

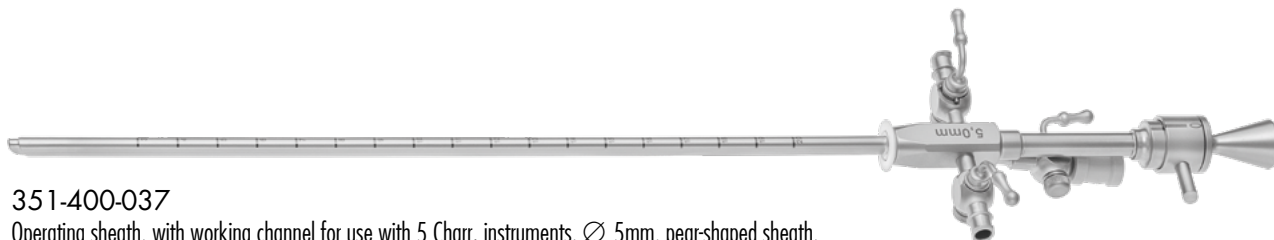

351-400-037
Operating sheath, with working channel for use with 5 Charr. instruments, ∅ 5mm, pear-shaped sheath,
248mm working length, with inflow and outflow stopcock, for use with 351-829-030 or 351-829-130

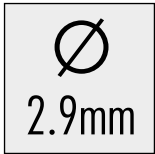

MIDI OPERATING HYSTEROSCOPE SETS

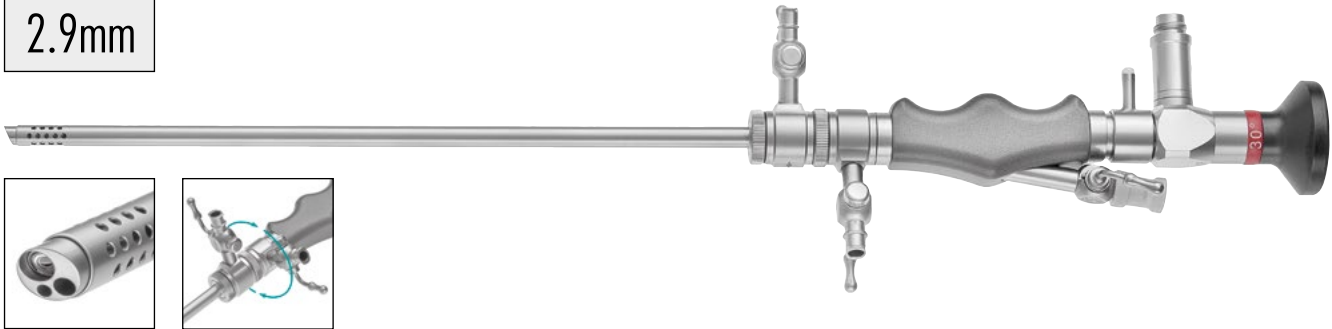

351-400-630 Compact Continuous-Flow sheath, Ø 6.0mm, 200mm working length, with working channel for use with 5 Charr. instruments, 2 rotating stopcocks for inflow and outflow, for use with Midi Hysteroscope 351-829-030 or 351-829-130

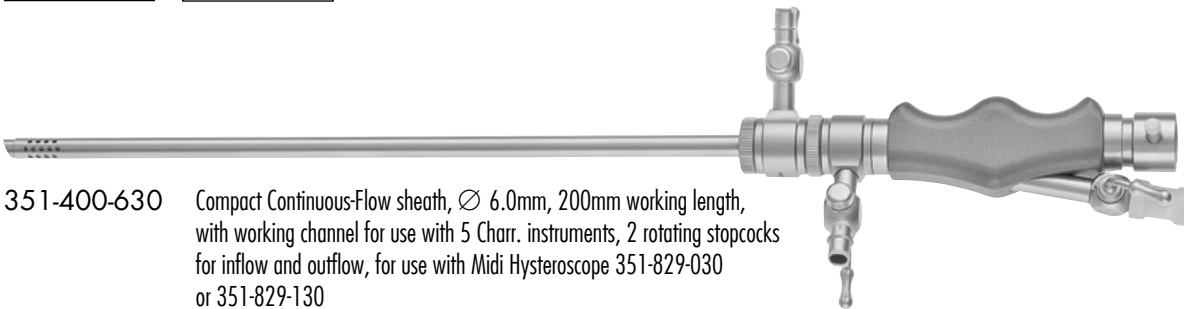

351-400-055 Compact Continuous-Flow sheath, Ø 5.5mm, with working channel for use with 5 Charr. instruments, 2 stopcocks for inflow and outflow, for use with Midi Hysteroscope 351-829-030 or 351-829-130

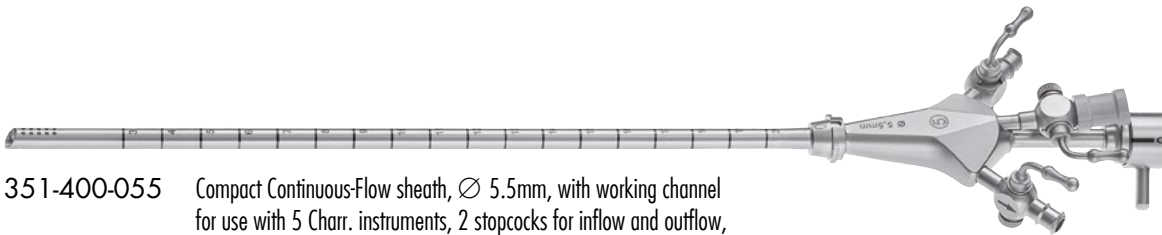

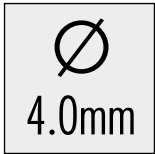

GRAND DIAGNOSTIC HYSTEROSCOPE SETS

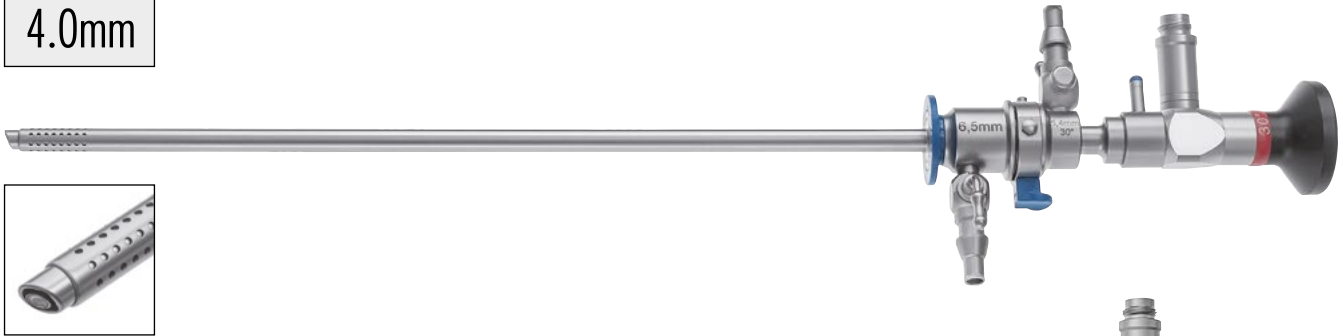

Hysteroscopes, ∅ 4.0mm, 300mm working length, overall length: 355mm
 351-804-000 0°
 351-804-030 30°

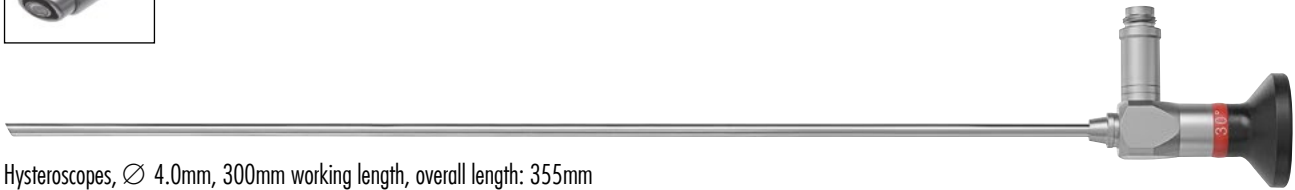

Diagnostic Sheath, ∅ 5.0mm, 270mm working length, with rotating stopcock, including obturator
 351-500-050 for 0° Hysteroscope
 351-530-050 for 30° Hysteroscope

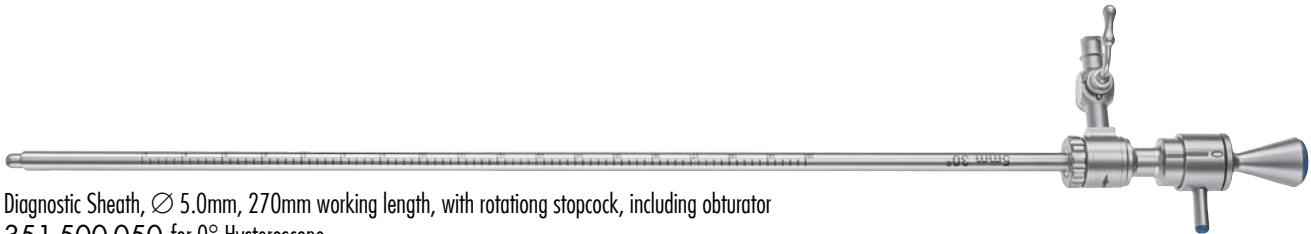

Diagnostic Sheath, ∅ 5.0mm, 270mm working length, with fixed stopcock, including obturator,
 recommended for **CO₂ gas dilation**
 351-630-050 for 30° Hysteroscope

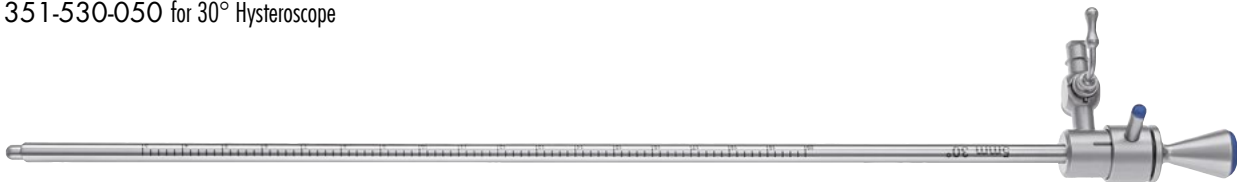

351-500-054 Diagnostic sheath, ∅ 5.4mm, 260mm working length, with inflow stopcock,
 including obturator, for use with outer sheath 351-500-065
 and Hysteroscope 351-804-030



351-500-065 Outer sheath, ∅ 6.5mm, 240mm working length, with outflow stopcock,
 for use with diagnostic sheath 351-500-054



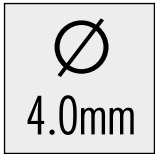

GRAND OPERATING HYSTEROSCOPE SETS

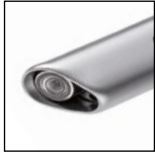
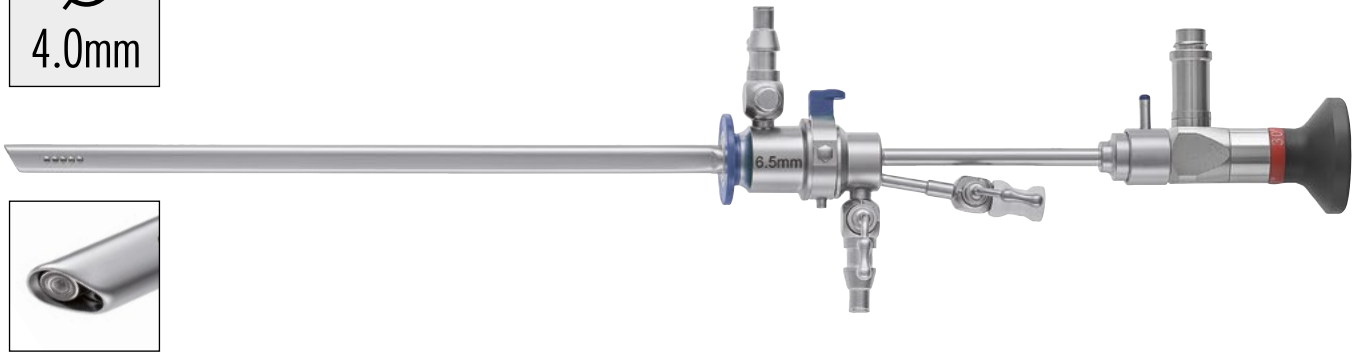

5
CHARR.
Instruments

192
mm
Working
length



351-500-160 Operating sheath, with inflow stopcock,
for use with outer sheath 351-500-060
and Hysteroscope 351-804-030

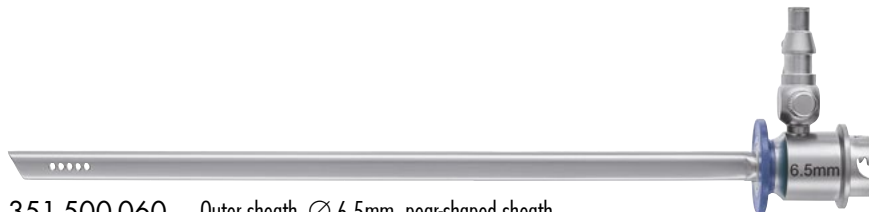

351-500-060 Outer sheath, ∅ 6.5mm, pear-shaped sheath,
with outflow stopcock, for use with operating sheath 351-500-160

7
CHARR.
Instruments

192
mm
Working
length

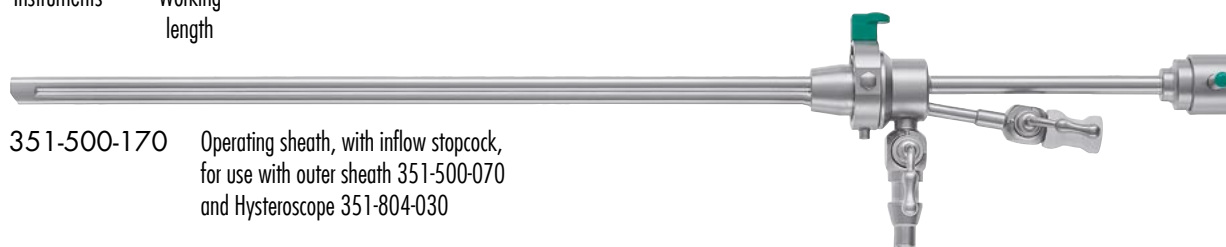

351-500-170 Operating sheath, with inflow stopcock,
for use with outer sheath 351-500-070
and Hysteroscope 351-804-030

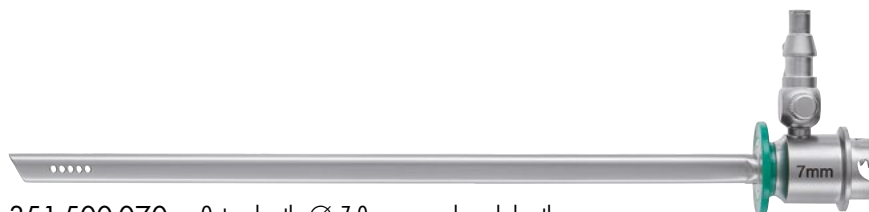

351-500-070 Outer sheath, ∅ 7.0mm, pear-shaped sheath,
with outflow stopcock, for use with operating sheath 351-500-170

360° rotating and color coded instruments, 5 Charr.

The unique design and features of the rotating color coded instruments have been designed in cooperation with Dr Accardi.

The automatic holding mechanism combined with the 360° rotation of the jaw and the light design will improve your comfort.

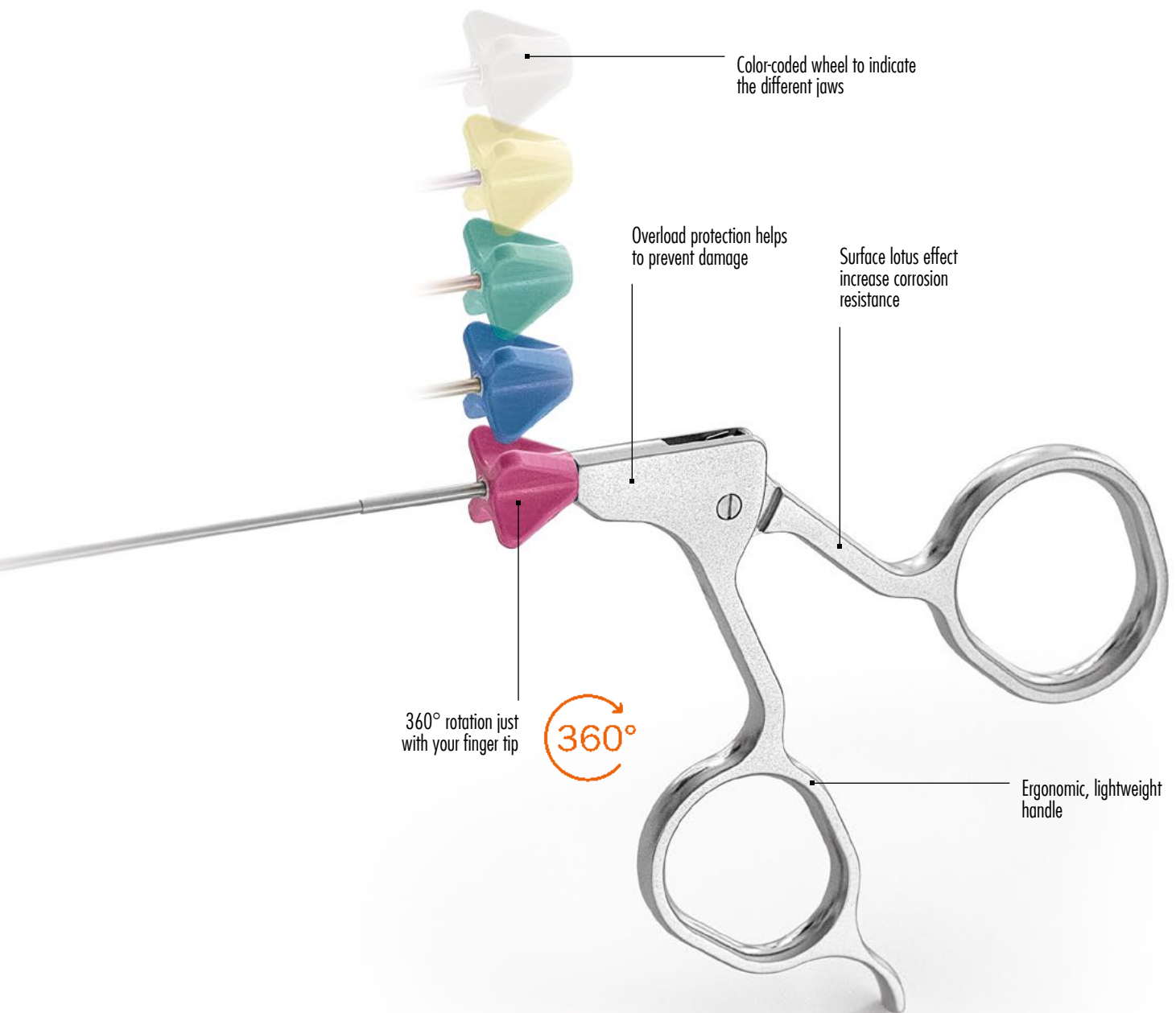

Color-coded wheel to indicate the different jaws

Overload protection helps to prevent damage



Surface lotus effect increase corrosion resistance

Ergonomic, lightweight handle

360° rotation just with your finger tip

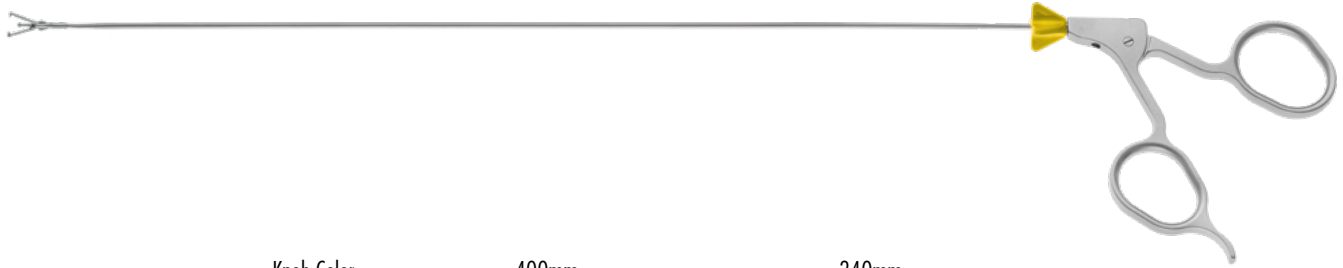



	Knob Color	400mm	340mm	
		351-116-305	351-116-335	Grasping Forceps with cup, serrated, double action
		351-118-305	351-118-335	Scissors, sharp tips, single action
		351-100-305	351-100-335	Scissors, blunt tips, single action
		351-126-305	351-126-335	Biopsy Punch Forceps, single action
		351-120-305	351-120-335	Biopsy Forceps, double action
		351-117-305	351-117-335	Tenaculum Forceps, 1x1 teeth, double action
		351-115-305	351-115-335	SHARK Tenaculum Grasping Forceps
		351-119-305	351-119-335	Accardi HARPOON Grasping Forceps, with barbs

6
CHARR.

FLEXIBLE & INSULATED INSTRUMENTS

for use with 7 Charr. working channel

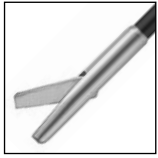

Scissors, blunt tips,
single action
351-100-205 400mm
351-100-235 340mm



Grasping Forceps with cup,
serrated, double action
351-116-205 400mm
351-116-235 340mm



Biopsy Forceps,
double action
351-120-205 400mm
351-120-235 340mm

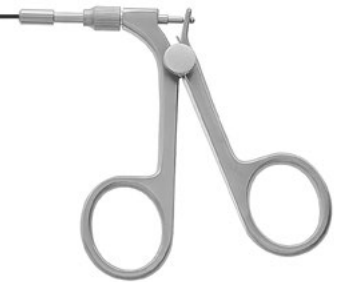

5
CHARR.

7
CHARR.

SEMI-RIGID INSTRUMENTS

400mm working length



Scissors, blunt tips, single action,
400mm working length
351-410-425 5 Charr.
351-410-427 7 Charr.



Biopsy Forceps, oval cup, serrated,
400mm working length
351-410-325 5 Charr.
351-410-327 7 Charr.



5
CHARR.

HEXAGONAL HANDLE INSTRUMENTS



Palpation Probe, graduated
351-125-105 400mm
351-125-135 340mm



Myoma Fixation Screw, semi-rigid
351-124-105 400mm
351-124-135 340mm



ELECTRODES

360mm working length



Bipolar Needle Electrode,
straight tip
351-360-005

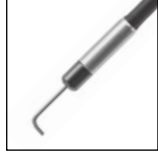

Bipolar Needle Electrode,
90° angled tip
351-360-015



Bipolar Ball Electrode,
360mm working length
351-370-105



ELECTRODES

360mm working length



Monopolar Needle Electrode
351-380-360



Monopolar Ball Electrode
351-385-360



SNARE

340mm working length

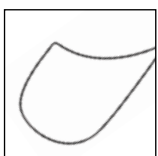
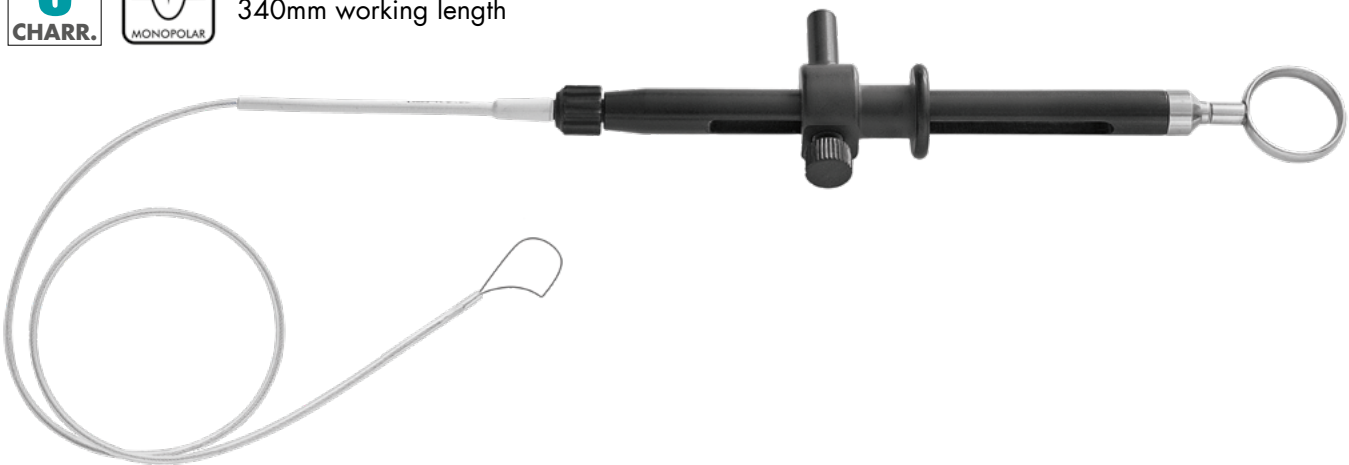

Polypectomy Snare
253-570-005

HIGH FREQUENCY CABLES 4.5m length



253-610-001* with 5 mm plug for Erbe HF-unit

253-610-002* with 4 mm plug for Martin HF-unit

253-610-003* with 8 mm plug for Valleylab HF-unit

253-610-004* with 4 mm plug for older HF-units

700-501-453* SDS plug

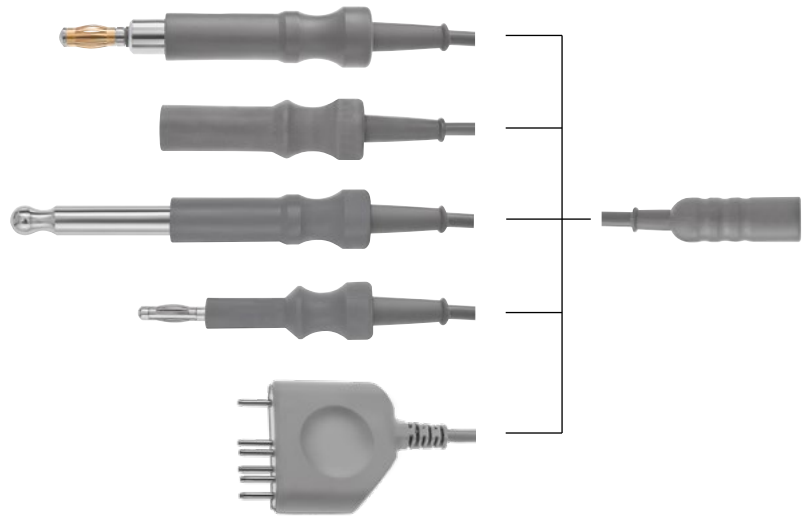

253-400-601 for Erbe HF-unit

253-400-602 for Martin HF-unit

700-500-453 SDS plug

700-400-606 for BOWA

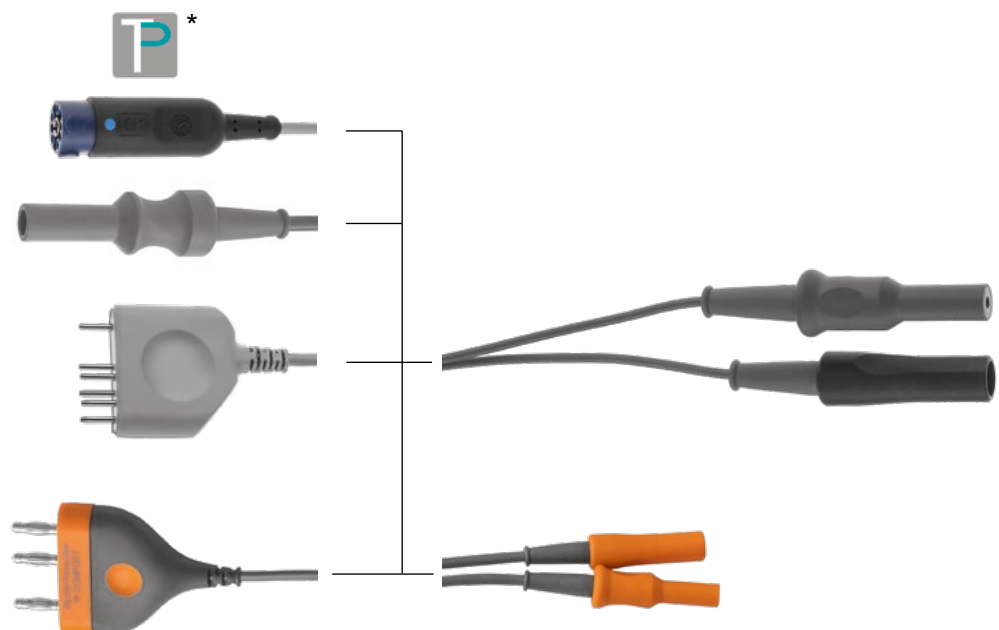

ADAPTORS & VALVES



300-011-181* Luer-Lock tube connector, 9mm



300-011-506* Luer-Lock tube connector, 6mm



300-011-184* Luer-Lock Tuohy Borst Adapter

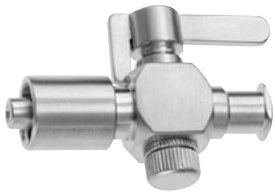

300-011-178 Luer-Lock one-way stop-cock with spring screw cap



300-011-179* Luer-Lock tube connector with stopcock



300-011-515* Luer-Lock one-way stopcock



351-905-110 Silicone Valve, reusable, for instruments up to Ø1.8mm (5.5Charr.), with LL-Connection, 10pcs. per package



301-701-100* Grey Rubber cap for use on all working channels



351-905-105 Disposable Silicone Valve with Luer-Lock connection for use with 3 - 10 Charr. instruments, package with 10 pieces, sterile packed



300-400-900* Rubber Seal for Luer-Lock connectors

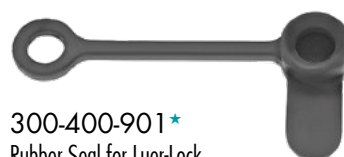

300-400-901* Rubber Seal for Luer-Lock connectors



RZ HYBRID RESECTOSCOPY SYSTEM

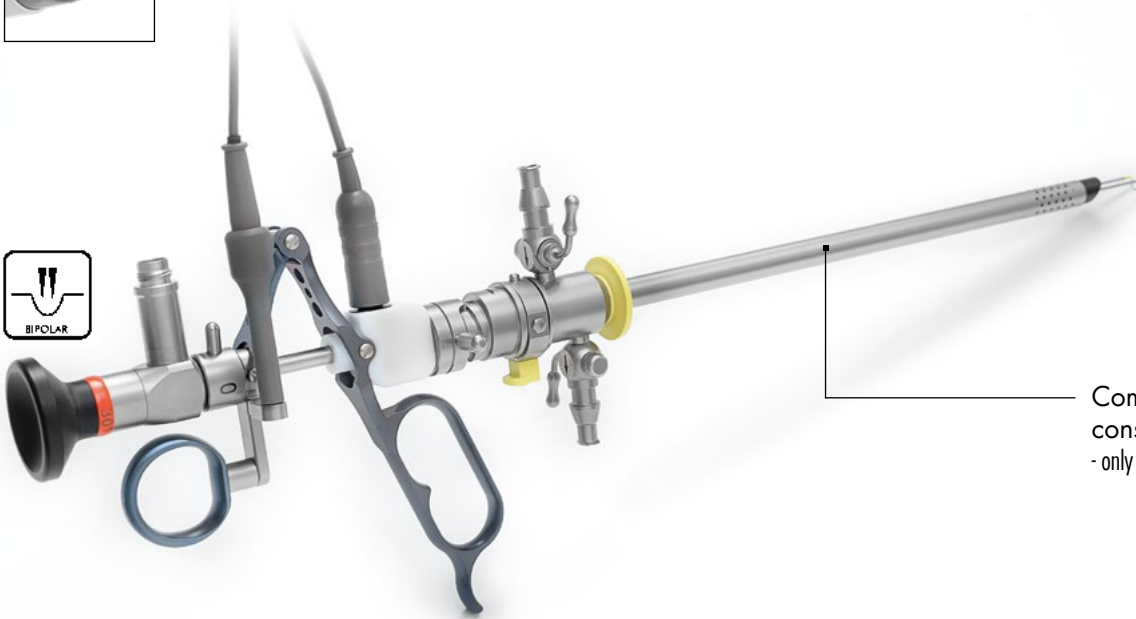

Complete Instrument consisting of **1-5**
- only cable needs to be changed

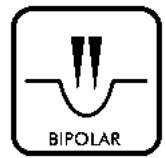
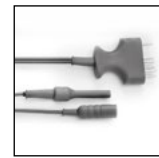

5



4

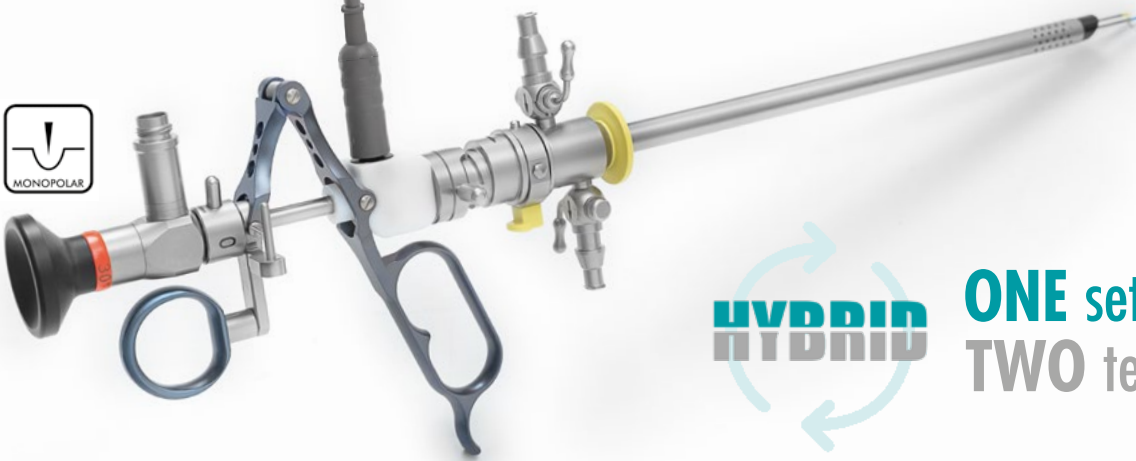

ONE set
TWO techniques

18.5
CHARR.

HYBRID
HYBRID

GRAZIA RESECTOSCOPY SYSTEM

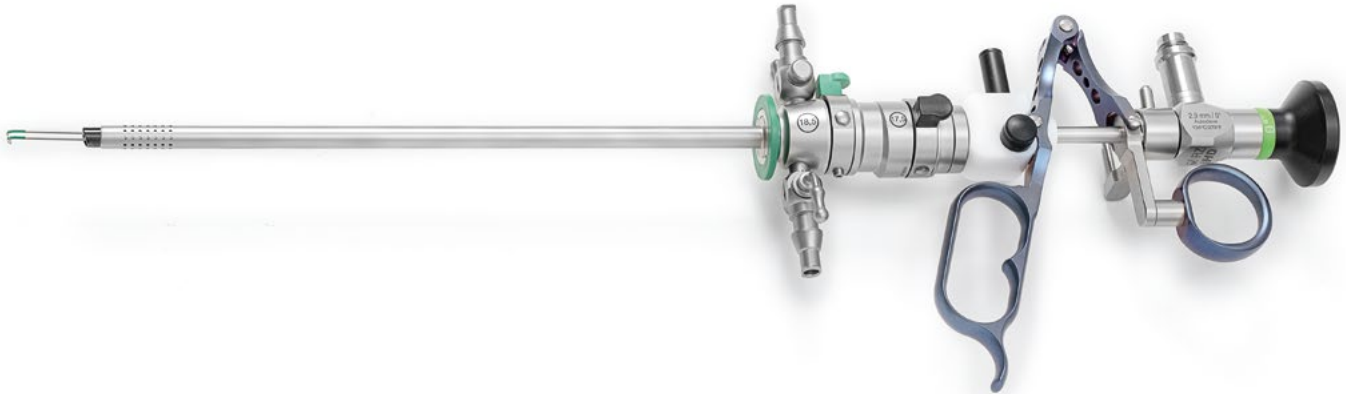

Endoscopes, suitable for HYBRID 18.5 Charr. System

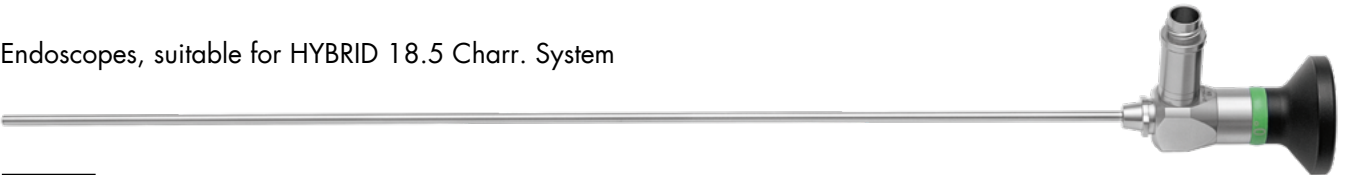

∅
2.9 mm

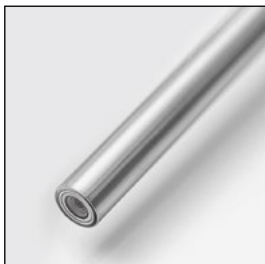

0° DIRECTION OF VIEW

300mm working length
356mm overall length 351-829-000



12° DIRECTION OF VIEW

300mm working length
356mm overall length 351-829-012



30° DIRECTION OF VIEW

300mm working length
356mm overall length 351-829-030

18.5
CHARR.

HYBRID
HYBRID

Sheath and Working Elements,
suitable for HYBRID 18.5 Charr. System

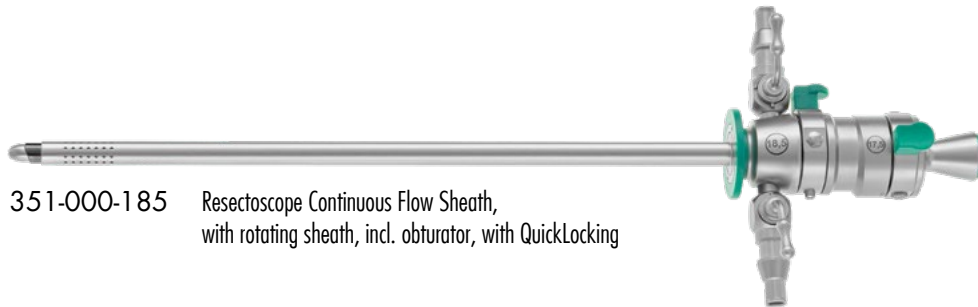

351-000-185 Resectoscope Continuous Flow Sheath,
with rotating sheath, incl. obturator, with QuickLocking



351-000-180 Visual Obturator, with 5 Charr. working channel



351-400-200 Passive Titanium Working Element







351-400-201 Active Titanium Working Element

18.5
CHARR.

HYBRID
HYBRID



Electrodes, 16 Charr., suitable for HYBRID 18.5 Charr. System





	Cutting Loop	351-000-201
	Cutting loop, straight	351-000-202
	Cutting loop, straight	351-000-203
	Ball Electrode	351-000-205
	Roller Electrode, 2mm	351-000-206



Accardi Cold Knives, 16 Charr., suitable for HYBRID 18.5 Charr. System

- no electricity - no myometrial scar and damage or perforation of the uterus
- one step procedure
- useful for all myomas G0 - G1 - G2
- safe procedure for the patient

 Italian Design
 Made in Germany

	Accardi Cometa	351-400-410
	Accardi Orbit	351-400-415
	Accardi Hook	351-400-420
	Accardi L-Hook	351-400-430



24
CHARR.

HYBRID
HYBRID

RESECTOSCOPY SYSTEM

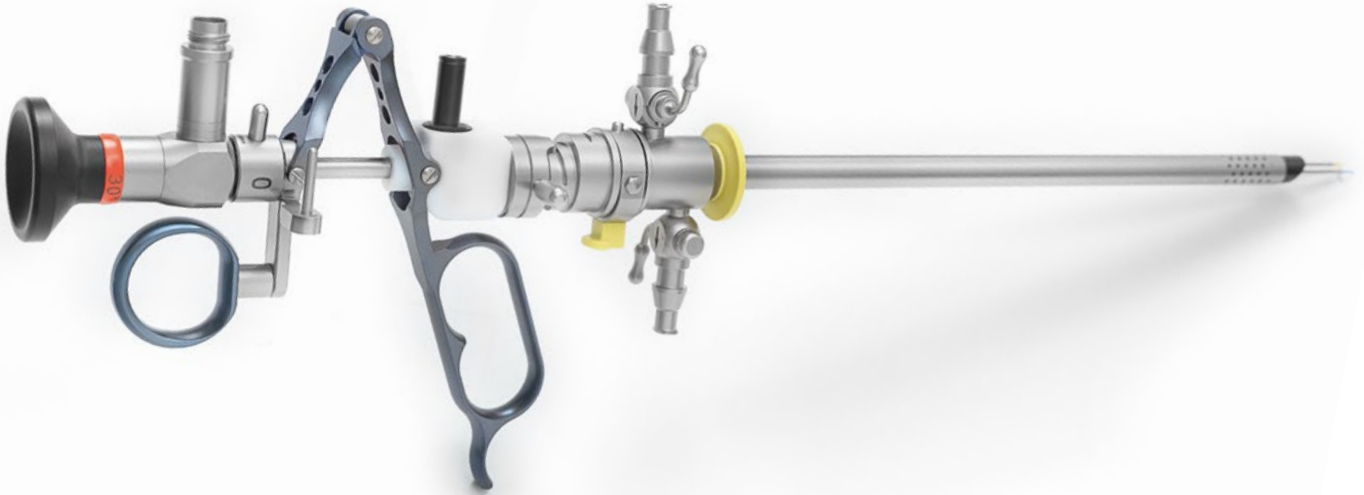

Endoscopes, suitable for HYBRID 24 Charr. System



∅
4 mm

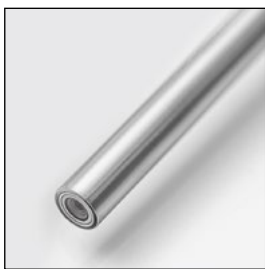

0° DIRECTION OF VIEW

300mm working length
356mm overall length 253-804-000*



12° DIRECTION OF VIEW

300mm working length
356mm overall length 253-804-012*



30° DIRECTION OF VIEW

300mm working length
356mm overall length 253-804-030*

24
CHARR.

HYBRID
HYBRID

Sheaths, suitable for HYBRID 24 Charr. System

253-000-256* Continuous Flow Resectoscope Sheath
Rotating inner sheath for 360° TURP/TURB.
Inner shaft with non reflecting, oblique ceramic tip.
RZ QuickLock mechanism, with Obturator



253-000-266 Inner shaft, 24Charr., with oblique ceramic tip for 253-000-256



253-000-084* Visual Obturator for 4mm RZ Cystoscopes,
for 24/26 Charr. resectoscope sheaths



253-000-094* Visual Obturator with 5 Charr. working channel,
for 4mm RZ Cystoscopes, for 24/26 Charr. resectoscope sheaths



24
CHARR.

HYBRID
HYBRID

Working elements suitable for HYBRID 24 Charr. System
with bipolar and monopolar cable connection

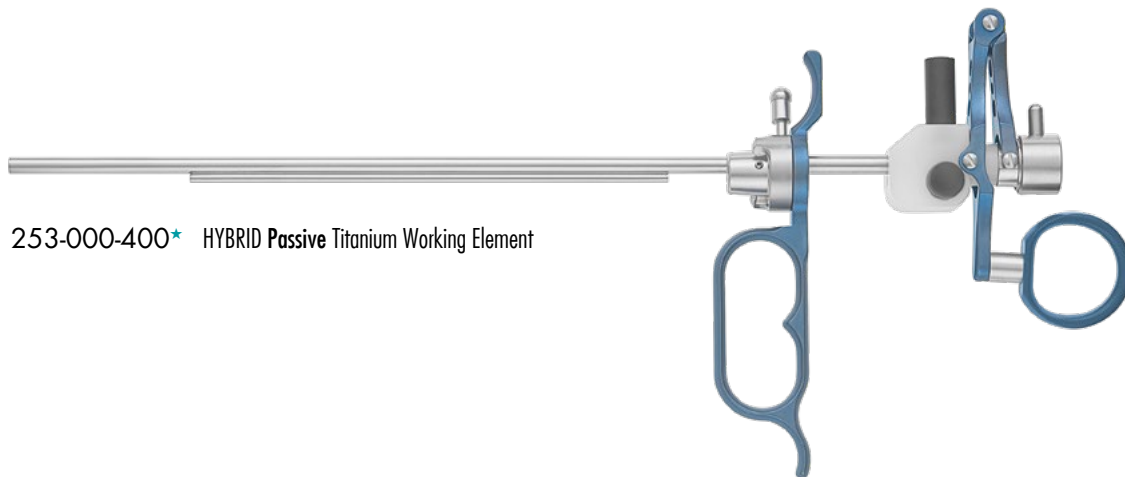
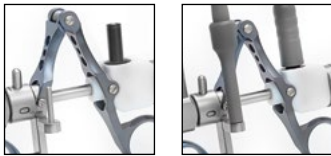

253-000-400* HYBRID Passive Titanium Working Element

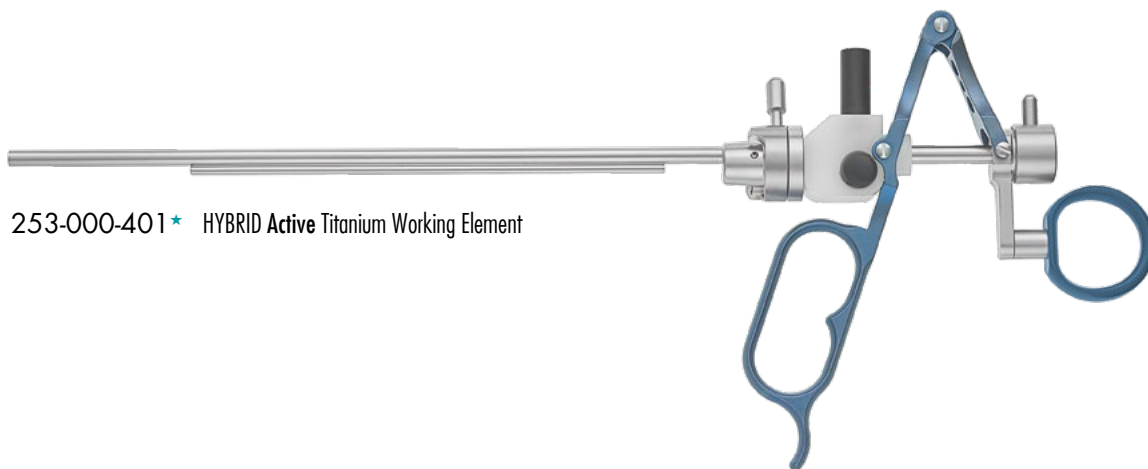

253-000-401* HYBRID Active Titanium Working Element

24
CHARR.

HYBRID
HYBRID

HYBRID Electrodes, 24 Charr., suitable for 24 Charr. System and 24 Charr. inner sheath

- works in bipolar and monopolar mode
- made of a standard wire of \varnothing 0.35mm



Cutting Loop, angled, for 12°/30° telescope

253-400-200



Cutting Loop, angled, for 12°/30° telescope

253-400-201*



Cutting Loop, thick wire, angled, for 12°/30° telescope

253-400-202



Collins Coagulation Electrode, pointed

253-400-203*



Coagulation Electrode, conical

253-400-204



Coagulation Electrode, ball shape, \varnothing 3mm

253-400-205*



Roller-Electrode, \varnothing 3mm

253-400-211



Accardi Cold Knives, 24 Charr., suitable for HYBRID 24 Charr. System

- no electricity - no myometrial scar and damage or perforation of the uterus
- one step procedure
- useful for all myomas G0 - G1 - G2
- safe procedure for the patient

 Italian Design

 Made in Germany



Accardi Loop

351-000-410



Accardi Rake

351-000-415



Accardi Knife

351-000-420

Bipolar Working Elements for GYNECARE-VERSAPOINT Bipolar Electrodes

RZ compatible



351-000-400
Passive Titanium Working Element for use with
 RZ Resectoscope Sheaths 253-000-256/253-000-356
 and 4mm, 12°/30° RZ Hysteroscopes
 351-804-012/351-804-030

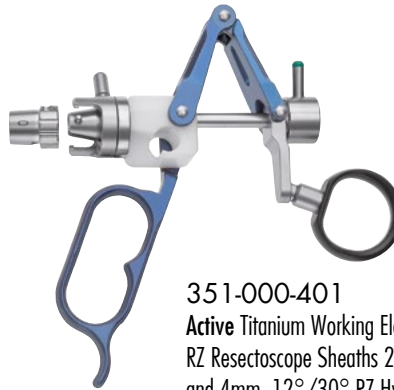

351-000-401
Active Titanium Working Element for use with
 RZ Resectoscope Sheaths 253-000-256/253-000-356
 and 4mm, 12°/30° RZ Hysteroscopes
 351-804-012/351-804-030

OLYMPUS compatible



351-000-500
Passive Titanium Working Element for use with
 OLYMPUS Resectoscope Sheaths and Telescopes



351-000-501
Active Titanium Working Element for use with
 OLYMPUS Resectoscope Sheaths and Telescopes

RICHARD WOLF compatible



351-000-600
Passive Titanium Working Element for use with
 R. WOLF Resectoscope Sheaths and Telescopes



351-000-601
Active Titanium Working Element for use with
 R. WOLF Resectoscope Sheaths and Telescopes

HIGH FREQUENCY CABLES

4.5m length



253-610-001* with 5 mm plug for Erbe HF-unit

253-610-002* with 4 mm plug for Martin HF-unit

253-610-003* with 8 mm plug for Valleylab HF-unit

253-610-004* with 4 mm plug for older HF-units

700-501-453* SDS plug

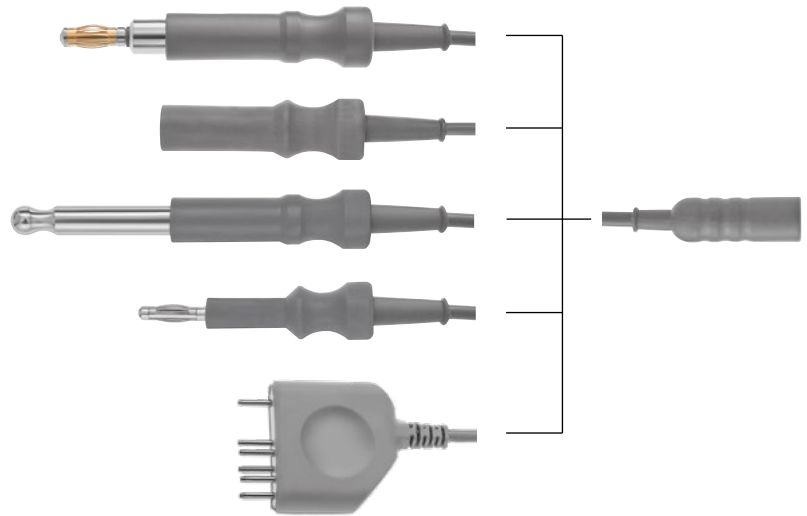

253-400-601 for Erbe HF-unit

253-400-602 for Martin HF-unit

700-500-453 SDS plug

700-400-606 for BOWA

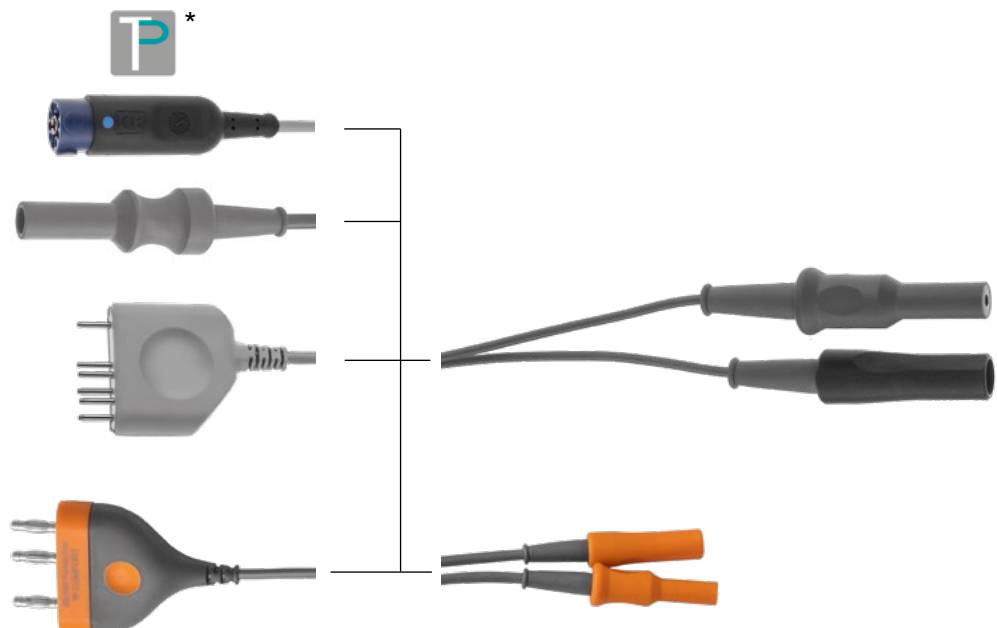

WIRE LOOP ELECTRODES

- autoclavable handle with monopolar connector
- loop which can be ordered as a spare part.
- to be used with a 5.5 mm trocar
- salvage of the cervix, no vaginal descensus.
- faster recovery of the patient.

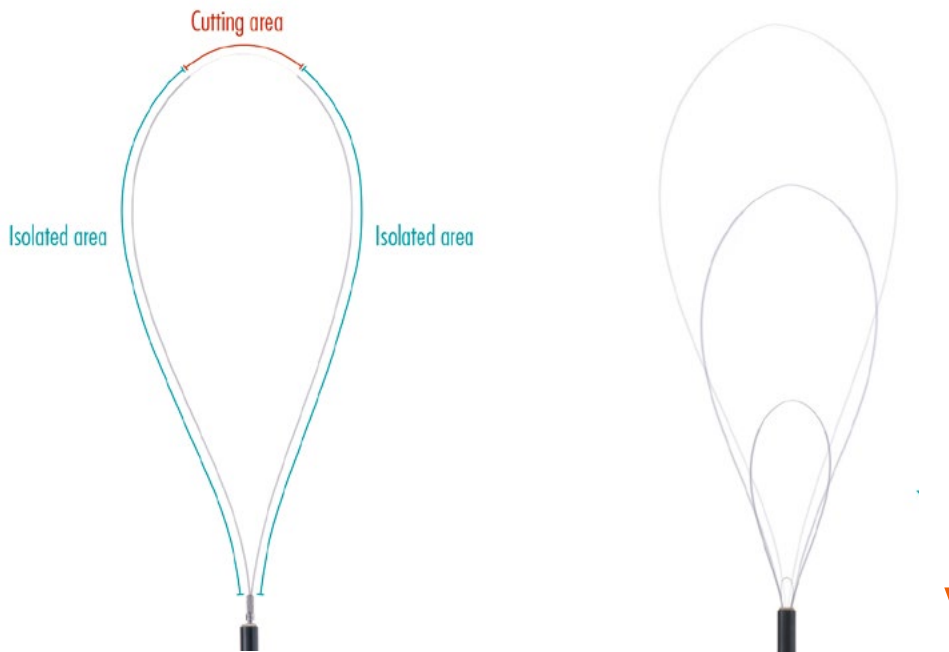

350-754-000 Wire Loop Electrode with \varnothing 100mm wire loop electrode

Spare Wire Loops (single use, non-sterile)

- 350-754-001 \varnothing 100mm
- 350-754-002 \varnothing 125mm
- 350-754-003 \varnothing 65mm

MICRO NEEDLE ELECTRODES

- extremely delicate needles
- can be retracted during surgery



Pulled out needle,
cutting function

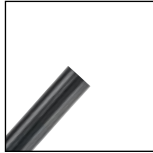

Retracted needle,
safe handling



Micro Needle Electrode for monopolar cutting

350-752-320 320mm

350-752-420 420mm

350-752-001 Spare Micro Needle (Quantity: 12)

COMBINED MICRO NEEDLE ELECTRODE

- for cutting and coagulation



Pulled out needle,
cutting & coagulation



Retracted needle,
coagulation only



Combined Micro Needle Electrode for cutting and coagulation

350-753-320 320mm

350-753-420 420mm

350-753-001 Spare Micro Needle (Quantity: 12)

GYNECOLOGY INSTRUMENTS

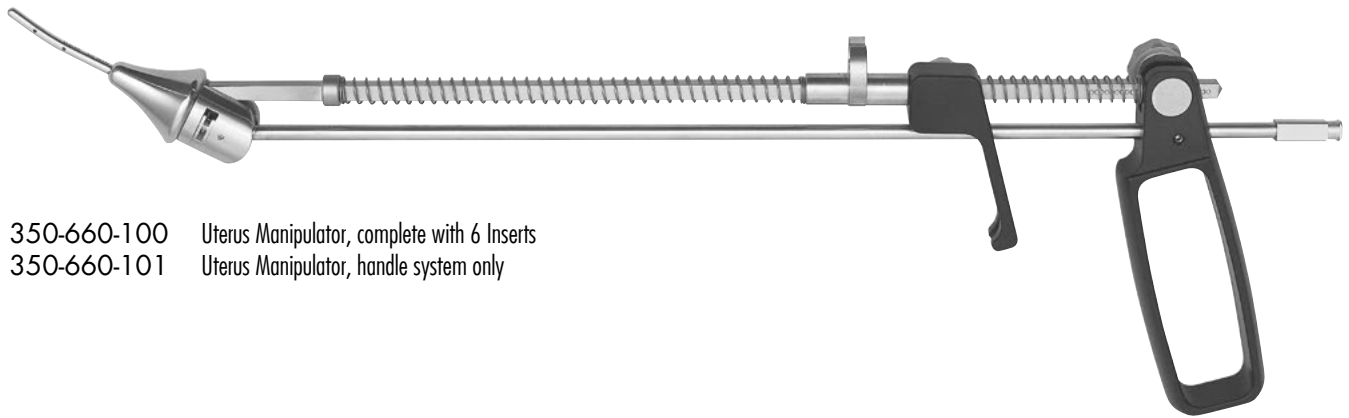

350-660-100 Uterus Manipulator, complete with 6 Inserts
 350-660-101 Uterus Manipulator, handle system only

Inserts



350-660-111
 Ø 8 x 80mm



350-660-112
 Ø 10 x 100mm



350-660-113
 Ø 3 x 45mm



350-660-114
 Ø 3 x 55mm



350-660-115
 Ø 3.2 x 34mm



350-660-116
 Ø 3.2 x 45mm



350-750-000 COHEN Uterus Cannula, complete with 2 interchangeable acorns

Acorns
 350-750-001 small
 350-750-002 large



1
MANGESHIKAR
 Uterus Manipulator, complete set
 350-740-000

2
 Tube with insulation ring
 350-740-005 35mm
 350-740-006 40mm
 350-740-007 45mm

3
 Intrauterus tip insert
 350-740-040 4x40mm
 350-740-050 5x50mm
 350-740-060 6x60mm
 350-740-070 7x70mm
 350-740-080 8x80mm

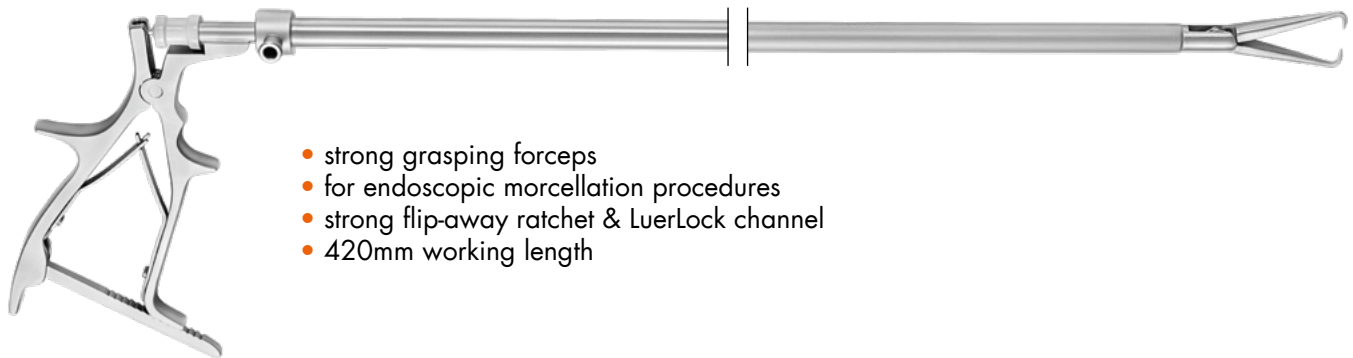

- strong grasping forceps
- for endoscopic morcellation procedures
- strong flip-away ratchet & LuerLock channel
- 420mm working length



Tenaculum Forceps,
 Ø10mm
 300-110-714



Claw Forceps,
 Ø10mm
 300-110-711



Tenaculum Forceps,
 Ø5mm
 300-110-715

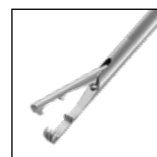

Claw Forceps,
 Ø5mm
 300-110-712

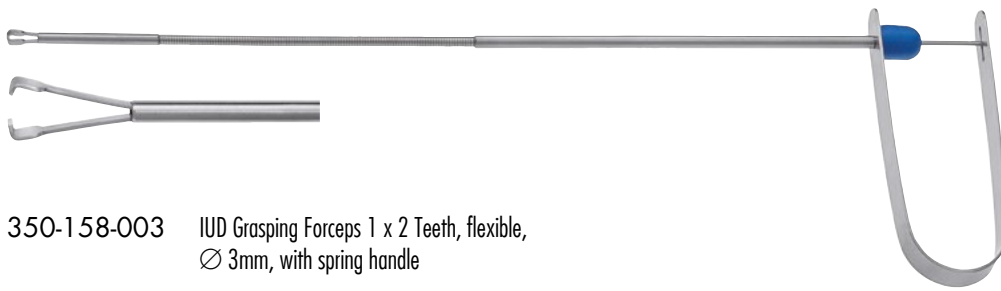

350-158-003 IUD Grasping Forceps 1 x 2 Teeth, flexible,
Ø 3mm, with spring handle



Myoma screw

- 300-032-015 Ø 5mm, 330 mm working length
- 300-042-005 Ø 5mm, 420 mm working length
- 300-033-010 Ø 10mm, 330 mm working length
- 300-042-010 Ø 10mm, 420 mm working length

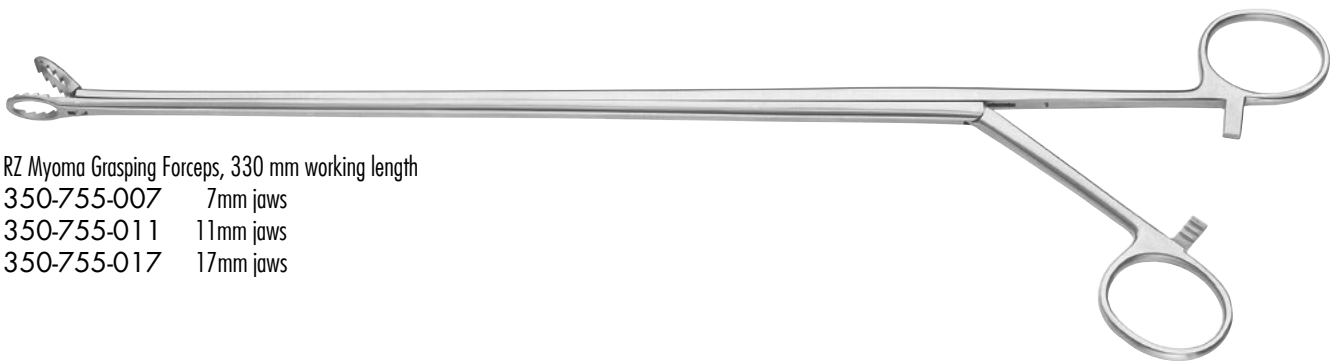

RZ Myoma Grasping Forceps, 330 mm working length

- 350-755-007 7mm jaws
- 350-755-011 11mm jaws
- 350-755-017 17mm jaws

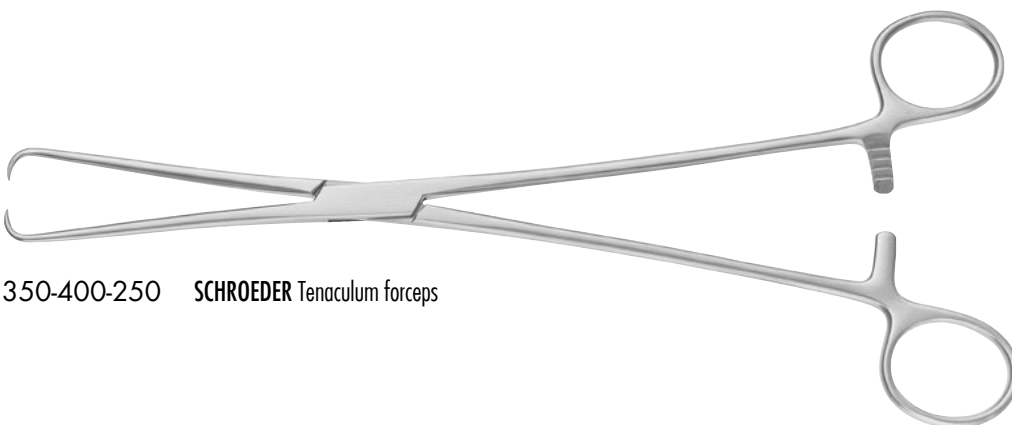

350-400-250 **SCHROEDER** Tenaculum forceps



351-815-160 Power light handle 3,6V, Xenon
incl. Storz-Adapter



Amnioscope Tubes, conical, with obturator, 200mm working length

351-815-012 12/24mm

351-815-016 16/24mm

351-815-020 20/24mm

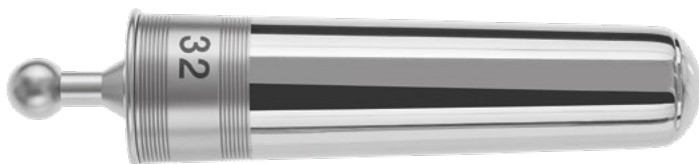

Amnioscope Tubes, conical, with obturator

351-815-118 18/40mm, 200mm working length

351-815-132 32/40mm, 140mm working length



Dittel Bougies, straight

253-320-225	8 Charr.	253-329-225	22 Charr.
253-321-225	9 Charr.	253-330-225	24 Charr.
253-322-225	10 Charr.	253-331-225	25 Charr.
253-323-225	11 Charr.	253-332-225	26 Charr.
253-324-225	12 Charr.	253-333-225	27 Charr.
253-325-225	14 Charr.	253-334-225	28 Charr.
253-326-225	16 Charr.	253-335-225	30 Charr.
253-327-225	18 Charr.	253-336-225	32 Charr.
253-328-225	20 Charr.	253-337-225	34 Charr.



Catheter for female

320-721-080	8 Charr.
320-721-100	10 Charr.
320-721-120	12 Charr.
320-721-140	14 Charr.
320-721-160	16 Charr.
320-721-180	18 Charr.
320-721-200	20 Charr.
320-721-220	22 Charr.
320-721-240	24 Charr.

SAFE+ CLEAN ENDOSCOPE PLASTIC CONTAINER with silicone bars on base and lid

600-505-000

Endoscopes	1 (∅ 1-10mm)
Endoscope length	max. 270mm
Dimensions	271 x 70 x 35mm

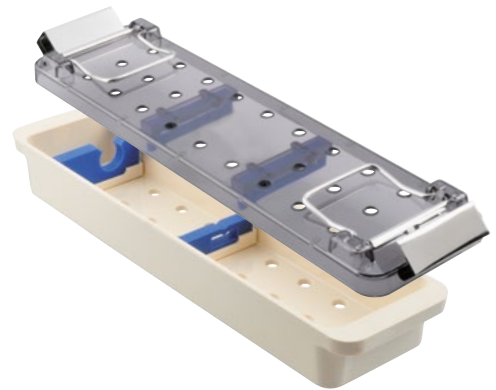

600-505-002

Endoscopes	max. 2
Endoscope length	max. 190mm
Dimensions	271 x 70 x 35mm

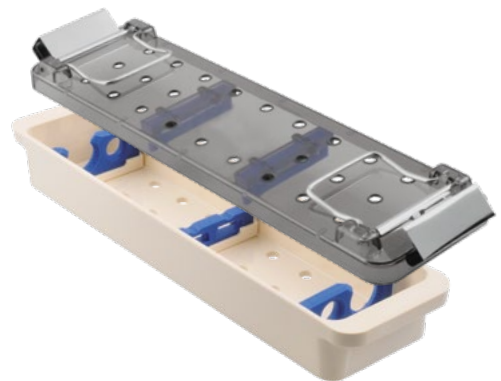

600-506-002*

Endoscopes	max. 2
Endoscope length	max. 390mm
Dimensions	394 x 70 x 35mm

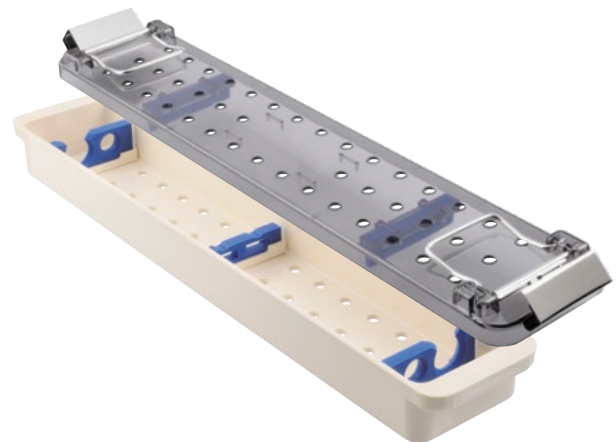

600-501-000

Endoscopes 1

600-501-002

Endoscopes max. 2

Endoscope length	max. 450mm
Dimensions	457 x 70 x 35mm

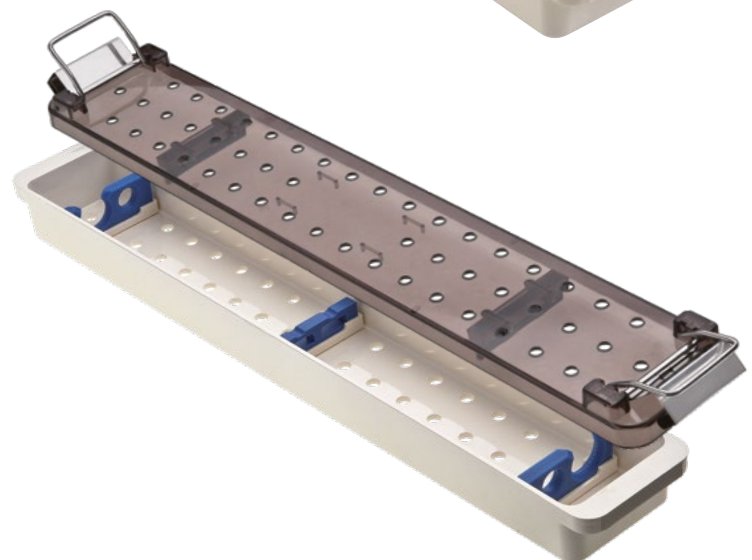

ENDOSCOPE & INSTRUMENT CONTAINERS

600-508-000	for scopes and light guide cables
Endoscopes	max. 3 (∅ 5-10mm)
Fiber Optic Light Cable	1
Endoscope length	max. XXXmm
Dimensions	465 x 212 x 51mm

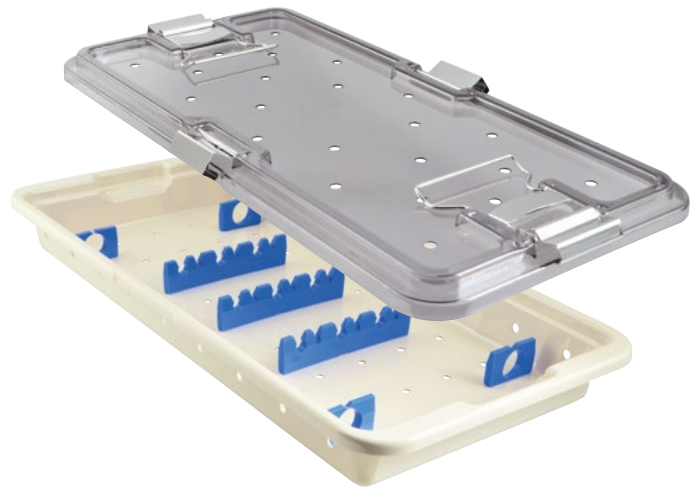

600-464-229	for fixation of instruments with rubber ties
Dimensions	464 x 229 x 51mm

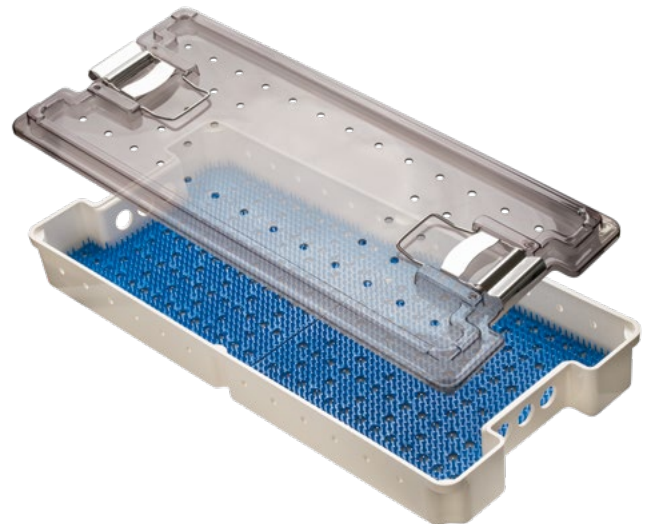

600-511-000	for instruments with rubber ties on 2 levels
Dimensions	502 x 239 x 102mm



ENDOSCOPE CLEANING BASKETS & CONTAINERS

with silicone bars on base and lid

600-292-052*

Endoscopes	max. 2
Endoscope length	max. 190mm
Dimensions	290 x 80 x 52mm

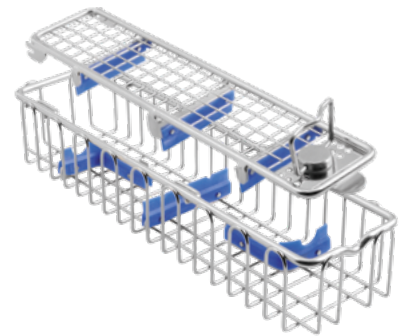

600-462-052*

Endoscopes	max. 2
Endoscope length	max. 350mm
Dimensions	460 x 80 x 52mm

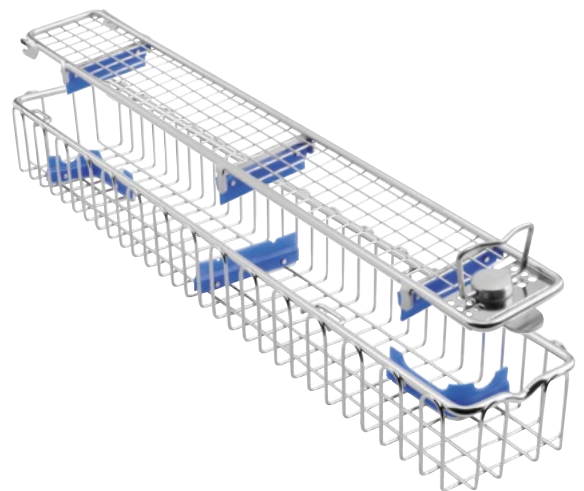

600-460-055	Endoscopes 1
600-460-056	Endoscopes max. 2
Endoscope length	max. 340mm
Dimensions	455 x 86 x 43mm

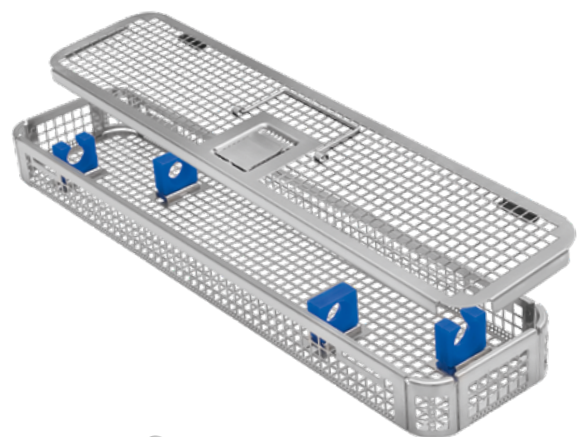

600-450-070

Endoscopes	max. 2
Endoscope length	max. 330mm
Dimensions	450 x 70 x 70mm

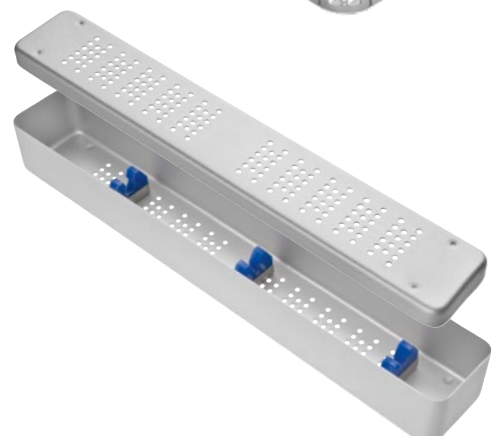

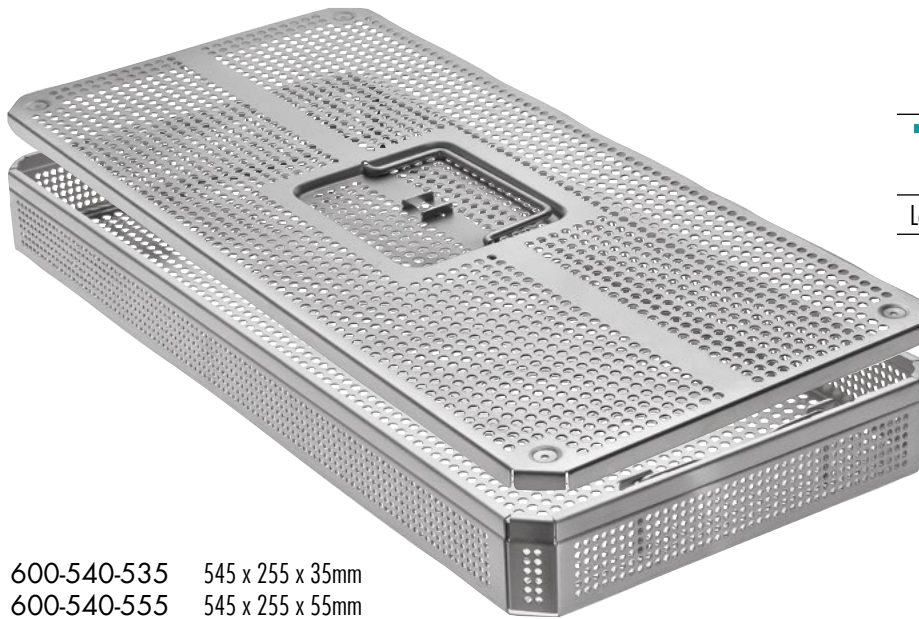

1/1	Stainless Steel Basket, round perforation, with lid
Length	545mm

- 600-540-535 545 x 255 x 35mm
- 600-540-555 545 x 255 x 55mm
- 600-540-575 545 x 255 x 75mm
- 600-540-605 545 x 255 x 105mm



- Lid only
- 600-540-500 545 x 255 mm



- Bottom only
- 600-540-530 545 x 255 x 30mm
- 600-540-550 545 x 255 x 50mm
- 600-540-570 545 x 255 x 70mm
- 600-540-600 545 x 255 x 100mm

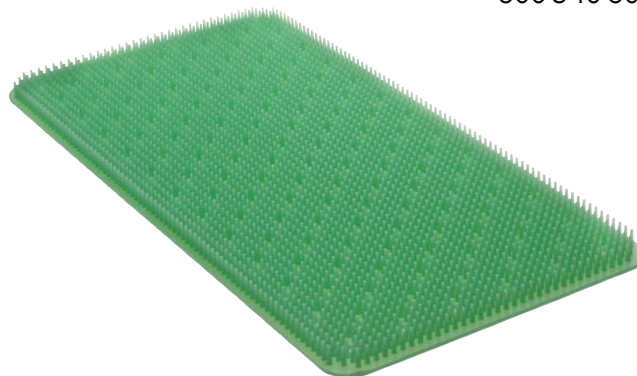

- 600-281-004 Silicone Mat green, 520 x 230mm

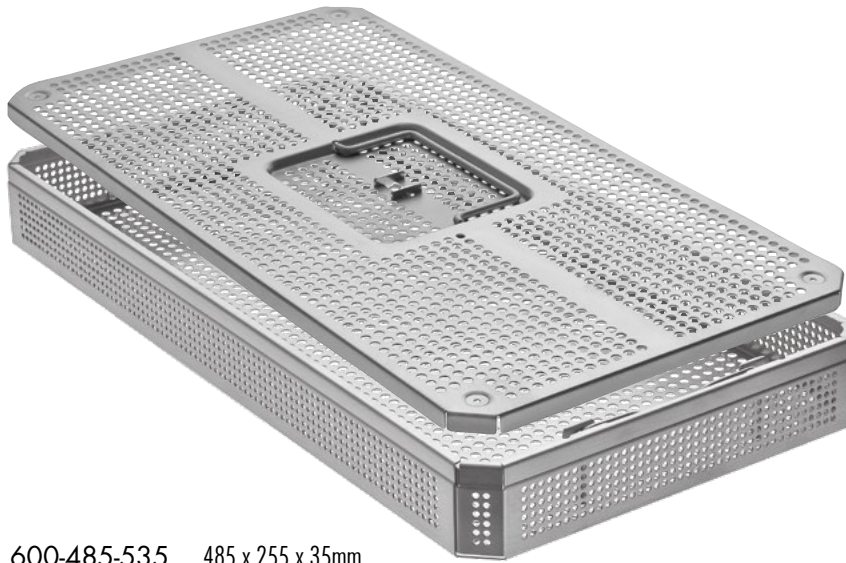

1/1

Stainless Steel Basket,
round perforation, with lid

Length

485mm

600-485-535 485 x 255 x 35mm
 600-485-555 485 x 255 x 55mm
 600-485-575 485 x 255 x 75mm
 600-485-605 485 x 255 x 105mm



Lid only
 600-485-500 485 x 255 mm

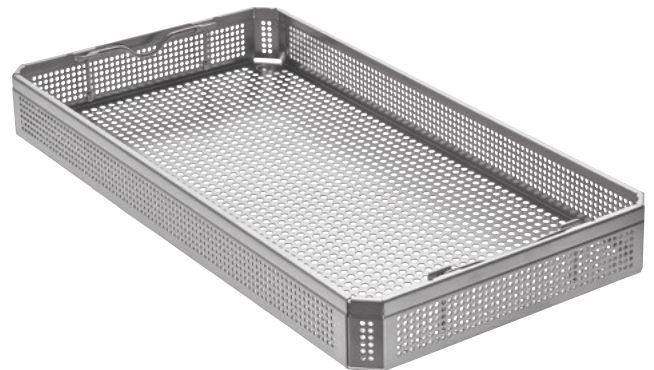

Bottom only
 600-485-530 485 x 255 x 30mm
 600-485-550 485 x 255 x 50mm
 600-485-570 485 x 255 x 70mm
 600-485-600 485 x 255 x 100mm



600-281-003 Silicone Mat green, 440 x 230mm

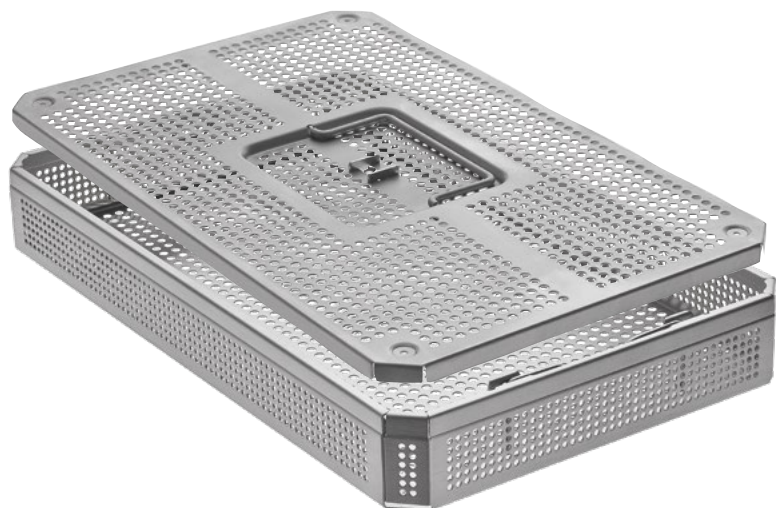

3/4

Stainless Steel Basket,
round perforation, with lid

Length

405mm

600-405-535 405 x 255 x 35mm
 600-405-555 405 x 255 x 55mm
 600-405-575 405 x 255 x 75mm
 600-405-605 405 x 255 x 105mm



Lid only
 600-405-500 405 x 255 mm

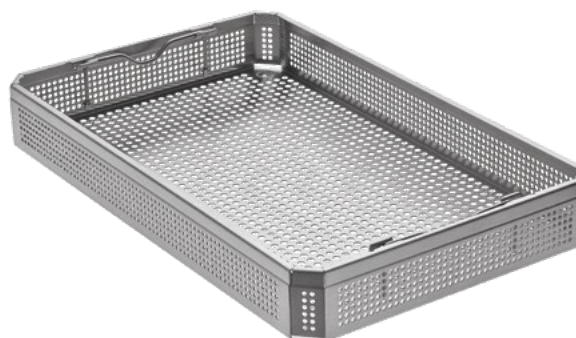

Bottom only
 600-405-530 405 x 255 x 30mm
 600-405-550 405 x 255 x 50mm
 600-405-570 405 x 255 x 70mm
 600-405-600 405 x 255 x 100mm

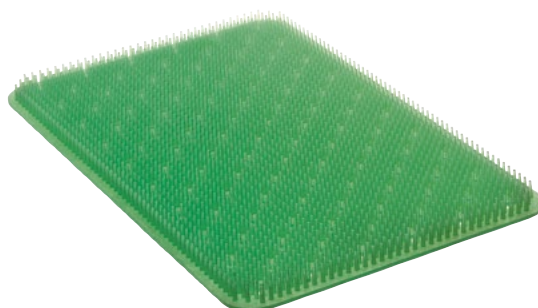

600-281-002 Silicone Mat green, 380 x 230mm



1/2

Stainless Steel Basket,
round perforation, with lid

Length

255mm

600-255-535 255 x 245 x 35mm
 600-255-555 255 x 245 x 55mm
 600-255-575 255 x 245 x 75mm
 600-255-605 255 x 245 x 105mm

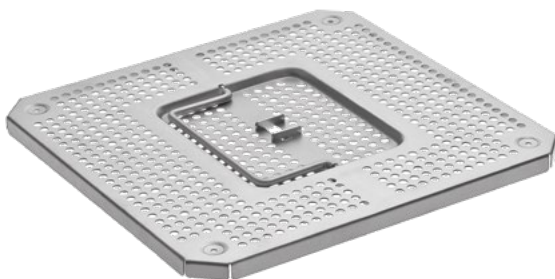

Lid only
 600-255-500 255 x 245 mm



Bottom only
 600-255-530 255 x 245 x 30mm
 600-255-550 255 x 245 x 50mm
 600-255-565 255 x 245 x 70mm
 600-255-600 255 x 245 x 100mm

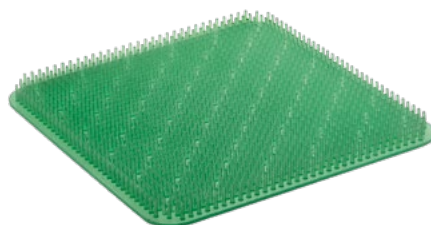

600-281-001 Silicone Mat green, 220 x 230mm

- Integrated safety lid
- Ergonomic, noise-reduced handles
- Color matched lid and handles
- Increased stability due to reinforced container walls
- Safe fluctuation of air and steam thanks to integrated spring system



Folding front handle



Color-matched safety lid



Colored handles



Size (LxWxH)



580 x 280 x 100mm

●	600-580-101	600-579-101
●	600-580-102	600-579-102
●	600-580-103	600-579-103
●	600-580-104	600-579-104
●	600-580-105	600-579-105
●	600-580-106	600-579-106



580 x 280 x 135mm

●	600-580-131	600-579-131
●	600-580-132	600-579-132
●	600-580-133	600-579-133
●	600-580-134	600-579-134
●	600-580-135	600-579-135
●	600-580-136	600-579-136



580 x 280 x 150mm

●	600-580-151	600-579-151
●	600-580-152	600-579-152
●	600-580-153	600-579-153
●	600-580-154	600-579-154
●	600-580-155	600-579-155
●	600-580-156	600-579-156



580 x 280 x 200mm

●	600-580-201	600-579-201
●	600-580-202	600-579-202
●	600-580-203	600-579-203
●	600-580-204	600-579-204
●	600-580-205	600-579-205
●	600-580-206	600-579-206



580 x 280 x 260mm

●	600-580-261	600-579-261
●	600-580-262	600-579-262
●	600-580-263	600-579-263
●	600-580-264	600-579-264
●	600-580-265	600-579-265
●	600-580-266	600-579-266

Size (LxWxH)



465 x 280 x 100mm	●	600-469-101	600-470-101
	●	600-469-102	600-470-102
	●	600-469-103	600-470-103
	●	600-469-104	600-470-104
	●	600-469-105	600-470-105
	●	600-469-106	600-470-106



465 x 280 x 135mm	●	600-469-131	600-470-131
	●	600-469-132	600-470-132
	●	600-469-133	600-470-133
	●	600-469-134	600-470-134
	●	600-469-135	600-470-135
	●	600-469-136	600-470-136



465 x 280 x 150mm	●	600-469-151	600-470-151
	●	600-469-152	600-470-152
	●	600-469-153	600-470-153
	●	600-469-154	600-470-154
	●	600-469-155	600-470-155
	●	600-469-156	600-470-156

Size (LxWxH)



285 x 280 x 100mm	●	600-280-101	600-279-101
	●	600-280-102	600-279-102
	●	600-280-103	600-279-103
	●	600-280-104	600-279-104
	●	600-280-105	600-279-105
	●	600-280-106	600-279-106



285 x 280 x 135mm	●	600-280-131	600-279-131
	●	600-280-132	600-279-132
	●	600-280-133	600-279-133
	●	600-280-134	600-279-134
	●	600-280-135	600-279-135
	●	600-280-136	600-279-136



285 x 280 x 150mm	●	600-280-151	600-279-151
	●	600-280-152	600-279-152
	●	600-280-153	600-279-153
	●	600-280-154	600-279-154
	●	600-280-155	600-279-155
	●	600-280-156	600-279-156



285 x 280 x 200mm	●	600-280-201	600-279-201
	●	600-280-202	600-279-202
	●	600-280-203	600-279-203
	●	600-280-204	600-279-204
	●	600-280-205	600-279-205
	●	600-280-206	600-279-206



285 x 280 x 260mm	●	600-280-261	600-279-261
	●	600-280-262	600-279-262
	●	600-280-263	600-279-263
	●	600-280-264	600-279-264
	●	600-280-265	600-279-265
	●	600-280-266	600-279-266

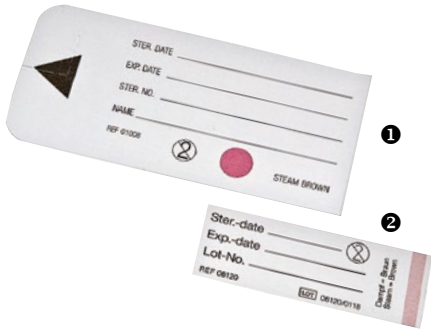

Identification label, 100 pieces per package
1 600-908-100 STANDARD
2 600-908-000 SMALL



600-909-000
 Plastic security seal,
 100 pieces per package

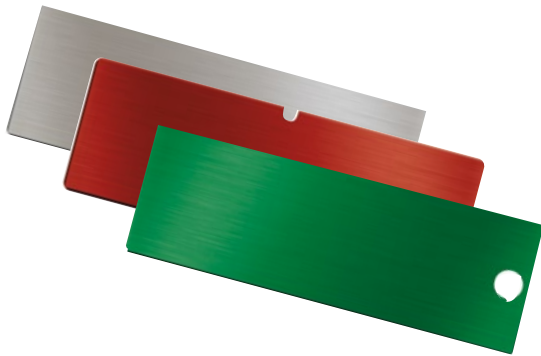

Identification label

with hole for snap hook
 56x17mm

with slot
 50x17mm

	with hole for snap hook 56x17mm	with slot 50x17mm
unmarked	600-900-040	600-900-041
	600-900-050	600-900-051
	600-900-060	600-900-061
	600-900-070	600-900-071
	600-900-080	600-900-081
	600-900-090	600-900-091
	600-900-100	600-900-101
	600-900-108	600-900-109
marked	600-900-110	600-900-111
	600-900-120	600-900-121
	600-900-130	600-900-131
	600-900-140	600-900-141
	600-900-150	600-900-151
	600-900-160	600-900-161

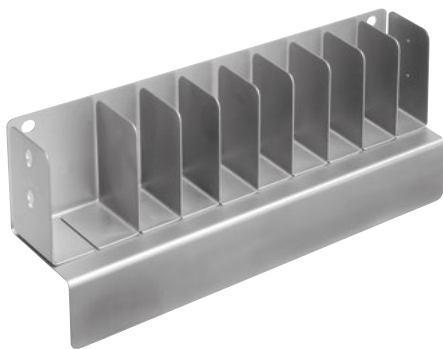

600-900-210
 Dispenser for identification labels
 (8 small compartments and 1 double compartment)
 as table or wall model



600-380-100
 PTFE (TEFLON) Filter, round, STANDARD



600-290-630
 Filter Dispenser for disposable Filter,
 round, 195x195mm

HYSTEROSCOPY

Cleaning



600-100-000
RZ-Aquajet
Water Jet Pistol complete
with 9 tips and 1m pressure
tubing, with strap and
suspension hook



600-050-000
Hand brush, autoclavable
(10 pcs. per box)



600-950-100
RZ - Brush dispenser
for 10 brushes with suspension hook



700-900-220 Special Cotton for polishing metal sheaths and instruments

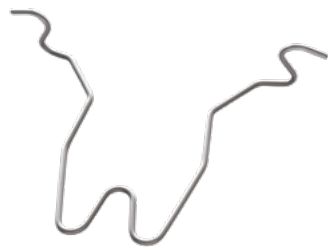

660-166-100
Holding Device for cleaning & sterilization

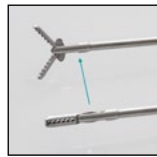

700-900-160
Instrument Oil in 50ml bottle



700-900-250
Oil Dispenser, 140mm



Cleaning brush (1 piece per box), 500mm length
300-135-905 for \varnothing 5 mm
300-135-910 for \varnothing 10 mm



300-215-000 Cleaning Brush, \varnothing 13mm, 215mm length, 60mm brush length



300-420-065 Cleaning Brush, \varnothing 3mm, 420mm length, 65mm brush length



Features:

- Versatile Irrigation Pump
- Pump leveling adjustment
- Pressure controlled roller pump

DELIVERY CONTAINS:

- Pump device
- Tubing set (253-910-001)
- Mains cable
- 2 Spare fuses
- Operating manual

351-100-200 Basic Irrigation Pump P1

Technical data

Line voltage	100-240 VAC
Power input	80VA
Irrigation power	0 - 0.5L/min
Pressure range	10 - 200mmHG
Measurements	380 x 130 x 400mm (WxHxD)
Weight	approx. 11kg

Accessories

253-910-001	Irrigation Tubing Set, silicone, autoclavable	non-sterile	included
253-910-002	Irrigation Tubing Set, PVC, 20 pieces, daily tube	sterile	optional
253-910-003	Patient tube, PVC, 2.5m, 40 pieces	sterile	optional

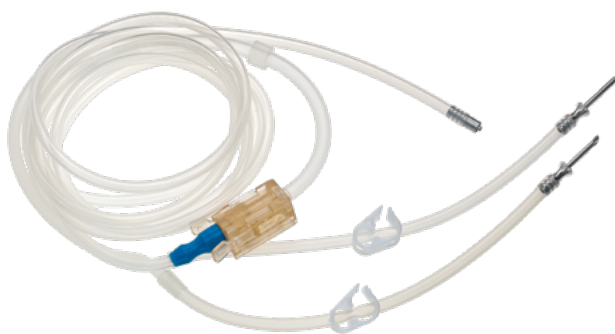



Features:

- 4K UHD resolution with 3-chip technology
- Image algorithm enhancement of color and structure
- 4K video recording
- 4K image saving
- Camera head with 4 programmable buttons
- Boost function
- Fog reduction
- Freeze function
- 2.5x digital zoom
- 10 USER mode configurations
- Multilingual on screen menu
- SDI 4K Output
- Text generator (optional with keyboard)

300-001-840 4K 3-Chip UHD-Camera K 4000

4K

DELIVERY CONTAINS:

- Main Unit (300-001-840)
- Camera head (300-001-841)
- HDMI cable
- USB Pen Drive
- Mains cable
- Operating manual

Technical data

Line voltage	100-240 VAC
Power consumption	60VA
Image sensor	3 MOS
Resolution	3840 x 2160 pixels (4K)
Index ratio	16:9
N/N ratio	54db

Video outputs	1x HDMI 4K
	1x HDMI FullHD
	1x SDI 4K
	1x SDI FullHD
Dimensions	Control unit: 355 x 103 x 350mm (WxHxD)
	Weight control unit: 6.2kg
	Weight camera head: 145g

Accessories



300-001-841
UHD 3-Chip Camera Head
(included in the set)



300-001-615
Title generator keyboard, waterproof IP68
US-Layout, cable 1.8m, color: grey,
305x140x15mm, 600gr.



300-001-610
Footswitch for HD Cameras
cable length: 2m



Features:

- Full HD camera with 3-chip MOS technology
- Pure Natural Colors technology
- Full HD video recording (F4 only)
- Full HD image saving (F4 only)
- Camera head with 3 programmable buttons
- Boost function
- Freeze function
- 2.5x digital zoom
- 3 USER mode configurations
- Multilingual on screen menu
- Different digital video outputs
- Text generator (optional with keyboard)

DELIVERY CONTAINS:

- Main Unit
- Camera head
- YPbPr/RGB cable
- 2x BNC cable
- Jack Cable
- HDMI - DVI cable
- HDMI cable
- S-Video cable
- USB Pen Drive (F4 only)
- Mains cable
- Operating manual

- 300-001-800 3 Chip HD-Camera F3
- 300-001-804 3 Chip HD-Camera F4 (with recording function)

FULL HD

Technical data

Line voltage	100-240 VAC
Power input	20W
Image sensor	3 MOS
Resolution	1920 x 1080 pixels (FullHD)
Image resolution	>1000 TV lines, horizontal
Index ratio	16:9
Min. sensitivity	< 3lx (1/1.4)
Shutter speed	1/50 (1/60) to 1/100.000sec

Video outputs (F4)	2 x HD SDI 1x HDMI / DVI 2x CVBS 1 x YPbPr / RGB 1 x Y/C (Pal/NTSC) 1x CVBS (Pal/NTSC)
Video outputs (F3)	1 x HDMI / DVI 1 x YPbPr (Component) 1 x Y/C (Pal/NTSC) 1x CVBS (Pal/NTSC)
Dimensions	Control unit: 380 x 120 x 360mm (WxHxD) Weight control unit: 11kg Weight camera head: 145g

Accessories



300-001-802
High-End 3-MOS Camera Head
FullHD (included in the set)



300-001-615
Title generator keyboard, waterproof IP68
US-Layout, cable 1.8m, color: grey,
305x140x15mm, 600gr.



300-001-610
Footswitch for HD Cameras
cable length: 2m



Features:

- Full HD camera with 1-chip MOS technology
- Natural color technology
- Full HD video recording (F2 Pro only)
- Full HD image saving (F2 Pro only)
- Camera head with 3 programmable buttons
- Boost function
- Freeze function
- 2.5x digital zoom
- 3 USER mode configurations
- Multilingual on screen menu
- HDMI video outputs
- Text generator (optional with keyboard)

300-001-600 HD-Camera F1
 300-001-601 HD-Camera F2 Pro (with recording function)

FULL HD

DELIVERY CONTAINS:

- Main Unit
- Camera head
- YPbPr/RGB cable
- 2x BNC cable
- HDMI - DVI cable
- HDMI cable
- S-Video cable
- Jack cable
- USB Pen Drive (F2 Pro only)
- Operating manual
- Mains cable

Technical data

Line voltage	100-240 VAC
Power input	F2 Pro: 30W / F1: 20W
Image sensor	1/3" MOS
Resolution	1920 x 1080 pixels (FullHD)
Image resolution	>1000 TV lines, horizontal
Index ratio	16:9
Min. sensitivity	< 3lx (1/1.4)

Video outputs (F2 Pro)	2 x HD SDI (optional) 1 x HDMI / DVI 1 x Y-Pb-Pr (Component) 1 x Video (PAL/NTSC) 1 x S-Video (PAL/NTSC)
Video outputs (F1)	1 x HDMI 1 x YPbPr / RGB 1 x S-Video (Y/C; Pal / NTSC) 1 x Video (CVBS; Pal / NTSC)
Dimensions	Control unit: 380 x 120 x 360mm (WxHxD) Weight control unit: 11kg Weight camera head: 105g

Accessories



300-001-602
 High-End 1/3" MOS Camera Head
 Full HD (included in the set)



300-001-615
 Title generator keyboard, waterproof IP68
 US-Layout, cable 1.8m, color: grey,
 305x140x15mm, 600gr.



300-001-610
 Footswitch for HD Cameras
 cable length: 2m



Features:

- Full HD camera with 1-chip technology
- Bright color technology
- Video and Picture recording (Z2 only)
- Camera head with 3 programmable buttons (Z2 only)
- Freeze function
- 2.5x digital zoom
- 3 USER mode configurations
- Multilingual on screen menu

- 300-001-400 Camera Z1
 300-001-410 Camera Z2 (with recording function)

DELIVERY CONTAINS:

- Main Unit (300-001-410)
- Camera head (300-001-410.1 / -400.1)
- HDMI/DVI Cable • HDMI cable
- 4GB USB Pen Drive (Z2 only)
- Mains cable • Operating manual

Technical data

Line voltage	100-240 VAC
Image sensor	1/3" MOS
Resolution	1920 x 1080 pixels (FullHD)
Index ratio	16:9
Outputs	1x HDMI
Connections	1x USB, 1x Remote IN 2 x Remote OUT, 2x RJ45

Safety class (EN 60601-1)	I
Classification (EU 2017/745)	I
Application part	BF
Dimensions	Control Unit: 380 x 132 x 378 mm (WxHxD) Camera Head: ∅ 38 x 79mm
Weight	Control Unit: approx. 9kg Camera Head: 180g

Accessories



300-001-410.1
1/3" MOS Camera Head for Z2
(included in the set)



300-001-400.1
1/3" MOS Camera Head for Z1
(included in the set)



300-001-615
Title generator keyboard, waterproof IP68
US-Layout, cable 1.8m, color: grey,
305x140x15mm, 600gr.



300-001-610
Footswitch for HD Cameras
cable length: 2m

TV COUPLER



4K
FULL HD

300-001-823 f=14mm
300-001-824 f=25mm
300-001-825 f=28mm
c-mount, soakable



4K
FULL HD

250-015-030
Zoom-TV-Adapter
f=15 - 30mm
c-mount, soakable



4K
FULL HD

250-015-036
Zoom-TV-Adapter
f=15 - 36mm
c-mount, soakable



FULL HD

300-001-813 f=14mm
300-001-814 f=25mm
300-001-815 f=28mm
c-mount, soakable



FULL HD

250-020-025 F=25mm (splitting 90/10)
250-020-030 F=30mm (splitting 90/10)
Beamsplitter, allows simultaneous video
and direct views, c-mount, soakable



300-001-168
Endovue 32" HD Monitor

300-001-158
Endovue 24" HD Monitor

Technical data

Screen size	31.5" / 24" diagonal
Resolution	1920 x 1080
Aspect ratio	16:9
Viewing angle	178°
Numbers of colors	16.7 Million (8-bit)
Video Inputs	DVI-D, RGBS/VGA/YPbPr (HD-15 or DVI-I via adapter), S-Video, Composite
Video Outputs	DVI-D
Weight	8.8kg (300-001-168) 6.7kg (300-001-158)



300-001-232
Radiance 32" HD Monitor

300-010-226
Radiance 27" HD Monitor

Technical data

Screen size	32" / 27" diagonal
Resolution	1920 x 1080
Aspect ratio	16:9
Viewing angle	178°
Numbers of colors	1.07 Billion (10-bit)
Video Inputs	DVI-I and 3G-SDI Input/Output
Video Outputs	DVI-D
Weight	11.0kg (300-001-232) 8.9kg (300-010-226)



300-001-031
UHD 4K Monitor, 31"

Technical data

Screen size	31" diagonal
Resolution	4096 x 2160
Aspect ratio	17:9
Viewing angle	178°
Number of colors	1.08 Billion (10-bit)
Video Inputs	1 x HDMI 2.0 1 x DP 1.2 (SST) & 1 x DP 1.2 (MST) 1 x DVI (single link), 4 x SDI (3G)
Video Outputs	1 x DP 1.2 (SST) 1 x DVI (single link), 4 x SDI (3G)
Weight	10.5kg

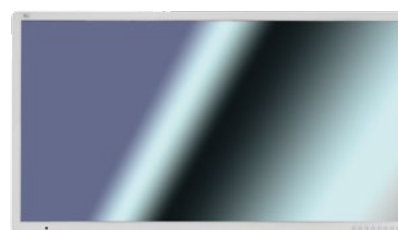

300-001-055
UHD 4K Monitor, 55"

Technical data

Screen size	55" diagonal
Resolution	3840 x 2160
Aspect ratio	16:9
Viewing angle	178°
Numbers of colors	1.08 Billion (10-bit)
Video Inputs	1 x HDMI 2.0, 2 x DP 1.2 (55T) 1 x DVI (single link), 2 x DVI (dual link) 4 x SOi (3G), 2 x SOi (12G)
Video Outputs	1 x DVI (single link), 1 x DP 1.2 (SST) 4 x SDI (3G), 2x SDI (12G)
Weight	37.35kg



Features:

- 6500K daylight color temperature
- 375 Watt equivalent output power
- > 20.000 hours lifetime
- Turret connector for the most common light cables (Olympus, Wolf, Gyrus ACMI, Storz)
- Manual or automatic light control
- Waterproof touch control panel
- Low heat conduction by improved LED technology
- Boost function: light increase of 20%

300-900-300 LUMEN LED 3 PRO Light Source, 110 - 230V



DELIVERY CONTAINS:

- Main Unit (300-900-300)
- BNC cable (optional)
- Mains cable
- Operating manual

Technical data

Line voltage	100-240 VAC
Video input	1x Video, BNC
Protection class	1 (acc. IEC 60601-1) 1 (acc. MDD 93/42/EEC)
Safety class	BF
Standard	IEC 60601-1-2
Dimensions	380 x 120 x 360mm (WxHxD)
Weight	approx. 11kg



Turret, multi connector

A **OLYMPUS**

B **WOLF**

C **GYRUS ACMI**

D **STORZ**
KARL STORZ ENDOSKOPIE



Features:

- More than 20.000h lamp lifetime
- 180 Watt equivalent power output
- Manual or automatic light control
- Waterproof touch control panel
- Low heat conduction by improved LED technology
- Daylight color temperature 6000 – 6500° K for accurate color representation
- Boost function: light increase of 20%

300-900-180 LUMEN LED 1 Light Source

DELIVERY CONTAINS:

- Main Unit (300-900-180)
- BNC cable
- Mains cable
- Operating manual



Technical data

Line voltage	100-240 VAC
Power consumption	130VA
Video input	1x Video, 1x S-Video (Y/C) (automatic version only)
Protection class	1 (acc. IEC 60601-1) 1 (acc. MDD 93/42/EEC)
Safety class	BF
Dimensions	380 x 120 x 360mm (WxHxD)
Weight	approx. 11kg

HIGH TEMPERATURE LED/XENON LIGHT CABLES

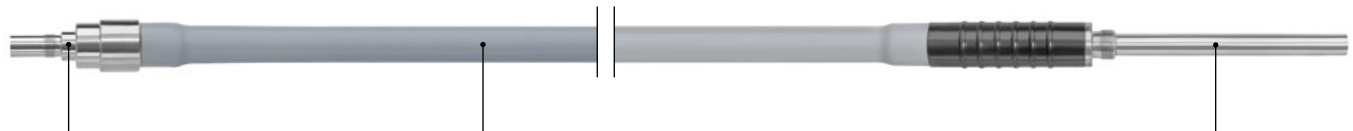

Adaptor pieces to use with **endoscope**



250-042-000
RZ/Storz/Olympus



250-040-000
Wolf



250-041-000
ACMI/British Standard

XENON/LED Light Guide Cables
with melt and bending protection

250-025-230 Ø 2.5 mm, 2300 mm

250-025-300 Ø 2.5 mm, 3000 mm

250-035-180 Ø 3.5 mm, 1800 mm

250-035-230 Ø 3.5 mm, 2300 mm

250-035-300 Ø 3.5 mm, 3000 mm

250-048-180 Ø 4.8 mm, 1800 mm

250-048-230 Ø 4.8 mm, 2300 mm

250-048-300 Ø 4.8 mm, 3000 mm

Adaptor pieces to use with **light source**



250-039-000
RZ/Storz



250-038-000
ACMI/CUDA



250-048-000
Luxtec



250-051-000
Stryker



250-037-000
Wolf



250-044-000
Olympus



250-045-000
Olympus - Standard



250-052-000
Heine



250-059-000
Pentax



COMPATIBILITY NOTE:

A fiber optic cable with a large diameter should not be connected to a smaller diameter scope.
For example: Ø 4.8mm fiber optic cables connected to a Ø 2.9mm may risk high temperature at the light entry of the endoscope and may risk patient safety.



Features:

- Monopolar/bipolar cutting and coagulation
- Automatic identification of connected instruments
- Powerstart System simplifies the beginning of cutting process
- Automatic power regulation
- 105 different memory locations in 7 groups
- Various output configuration of the sockets available
- 10" Touchscreen
- Tiltable display
- Footswitch (optional)
- Available with Argon and / or the RZeal
- Real-time output monitoring

DELIVERY CONTAINS:

- Main Unit
- Mains Cable
- (Footswitch not included)

700-350-400 230V
 700-350-410 110V
 G400 Electrosurgical Generator

Technical data

Line voltage	110-230 VAC
Power consumption	500W
Generator operation frequency	333kHz
Display	TFT 10"
Defibrillation impulse resistance	acc. to to EN 60601-1
NEM system	neutral electrode control optical indication 7 levels required resistance < 240 Ω
Gas type	pure argon 4.8 (99,998%) or higher
Inlet gas pressure	0.25-0.4 [MPa]
Monopolar coagulation / cutting	200W / 400W
Bipolar coagulation / cutting	400W / 400W

Gas outflow	0.1-10 l/min, regulated 0.1 l/min in whole range
Pressure range	reducer (0.4 MPa) on argon cylinder
Vessel sealing system	9 effects/300W
AutoStop	automatic stop of sealing process after achieving the optimal effect
Dimensions	495 x 415 x 225mm (LxWxH)
Weight	12.2kg

Accessories



700-350-405
 2-Button-Footswitch, length: 5m

700-350-402
 3-Button-Footswitch, length: 5m, quick access key



Disposable Neutral Electrode hydrogel, split, for adults or children
 10x5 pcs. per package
 700-503-000 Adults
 700-503-001 Children



Cable for Disposable Neutral Electrode
 5m, RZ compatible only
 700-503-003



Features:

- Monopolar/bipolar cutting and coagulation
- Automatic instrument detection system
- Intuitive Touchscreen
- Automatic power regulation
- Configurable working modes
- Real-time parameter control
- Special endoscopic modes
- Bipolar resection
- Easy software update

700-340-400 230V
 700-340-410 110V
 G44 Electrosurgical Generator

DELIVERY CONTAINS:

- Main Unit
- Mains Cable
 (Footswitch not included)

Technical data

Line voltage	110-240 VAC
Power consumption	1100VA
Generator operation frequency	333kHz
Display	TFT 7" WVGA
Spectrum result system	automatic power regulation
Monopolar coagulation	max. 200W (200Ω)
Monopolar cutting	max. 400W (100Ω)
Bipolar coagulation	max. 400W (25Ω)
Bipolar cutting	max. 330W (150Ω)

NEM system	neutral electrode control, optical indication, required resistance < 240 Ω
Dimensions	385 x 305 x 141mm (LxWxH)
Weight	7kg

Accessories



700-350-405
 2-Button-Footswitch, length: 5m

700-350-402
 3-Button-Footswitch, length: 5m, quick access key



Disposable Neutral Electrode
 hydrogel, split, for adults or children
 10x5 pcs. per package
 700-503-000 Adults
 700-503-001 Children



Cable for Disposable Neutral Electrode
 5m, RZ compatible only
 700-503-003